

User Manual

Euroklav[®] 23 S+

Steam sterilizer

from software version 5.15



EN

Dear doctor,

We thank you for your confidence demonstrated by the purchase of this MELAG product. As an owner-run and operated family concern founded in 1951, we have a long history of successful specialization in hygiene products for practice-based use. Our focus on innovation, quality and the highest standards of operational reliability has established MELAG as the world's leading manufacturer in the instrument treatment and hygiene field.

You, our customer are justified in your demand for the best products, quality and reliability. Providing "**competence in hygiene**" and "**Quality – made in Germany**", we guarantee that these demands will be met. Our certified quality management system is subject to close monitoring: one instrument to this end is our annual multi-day audit conducted in accordance with ISO 13485. This guarantees that all MELAG products are manufactured and tested in accordance with strict quality criteria.

The MELAG management and team.

Contents

1 General guidelines	5
Symbols used.....	5
Formatting rules	5
Symbols on the device	5
2 Safety	7
3 Performance specifications	9
Intended use	9
Sterilization procedure	9
Type of the feed water supply	10
Safety equipment	10
Overview of the sterilization programs	11
Program sequences	11
Overview of programs	12
4 Description of the device	14
Scope of delivery.....	14
Views of the device	15
Operating panel.....	16
Load mounts	17
5 First steps	18
Setup and installation.....	18
Feed water supply.....	18
Wastewater connection.....	19
Switching on the steam sterilizer.....	19
Opening and closing the door	19
Setting the date and time	19
6 Loading the steam sterilizer	21
Preparing the sterilization material.....	21
Loading the steam sterilizer	22
7 Sterilization	24
Selecting the program	24
Additional program options	25
Starting the program	25
Program run	26
Program end	27
Manual program abort.....	27
Removing the sterilized equipment	28
Storing sterile instruments.....	29
8 Logging	30
Batch documentation	30
Output media.....	30
Outputting logs immediately and automatically.....	33
Subsequent log output	33
Displaying the log memory.....	34

Deleting logs in the internal log memory	35
Reading logs correctly.....	35
9 Function tests	37
Automatic functional checks.....	37
Manual functional checks.....	37
Bowie & Dick test	37
Checking the quality of the feed water	38
Checking the pre-heating temperature of the chamber.....	38
10 Maintenance.....	39
Servicing intervals	39
Cleaning	39
Avoiding staining	41
Replacing the door seal	41
Replacing or sterilizing the sterile filter.....	42
Cleaning the filter in the chamber	44
Maintenance.....	44
11 Pause times	45
Frequency of sterilization	45
Operating pauses.....	45
Decommissioning.....	45
Recommissioning after relocation	45
12 Malfunctions	46
Warnings	47
Fault messages.....	49
Opening the door in an emergency following a power outage.....	54
Replacing the device fuses	55
13 Technical data	56
14 Accessories and spare parts	57
Glossary	58



1 General guidelines

Please read this user manual carefully before commissioning the device. The user manual includes important safety information. The functionality and value-retention of this device depends on the care accorded to it. Please store these user manual carefully and in close proximity to your device. It represents a component of the product.

Should the user manual no longer be legible, damaged or lost, please obtain a new copy from MELAG. State the device type and your address in an e-mail.

The device type is specified on the type plate on the rear of the device.

Symbols used

Symbol	Explanation
	Indicates a dangerous situation, which if not avoided, could entail slight to life-threatening injuries.
	Draws your attention to a situation, which if not avoided, could result in damage to the instruments, the practice fittings or the device.
	Draws your attention to important information.

Formatting rules

Example	Explanation
see Chapter 2	Reference to another text section within this document
Universal-Program	Words or phrases appearing on the display of the device are marked as display text.

Symbols on the device



Manufacturer of the medical device



Date of manufacture of the medical device



Medical device serial number from the manufacturer



Article number of the medical device



Information about the chamber volume



Operating temperature of the device



Operating pressure of the device



The user manual includes important safety information. Failure to comply with these instructions can result in injury and material damage.



Please read this user manual carefully before commissioning the device.



In affixing this CE mark, the manufacturer declares that this medical product fulfils the basic requirements of the Medical products directive. The four-digit number confirms that this is monitored by an approved certification agency.



In affixing this CE mark, the manufacturer declares that this medical product fulfils the basic requirements of the Pressure equipment directive. The four-digit number confirms that this is monitored by an approved certification agency.



With the adjacent label, the device manufacturer declares that the medical product corresponds to the basic requirements of the European standard DIN EN 1717 - Protecting Drinking Water from Contamination.



The device may not be disposed as domestic waste. The vendor is responsible for appropriate disposal of the device - it must be delivered to the vendor to be disposed of. In affixing this symbol, the manufacturer furthermore declares that he has satisfied all the legal requirements pertaining to the release, redemption and environmentally sound disposal of electric and electronic appliances.

MELAG devices are synonymous for long-term quality. When you eventually need to decommission your MELAG device, we offer a special disposal service. Simply contact your stockist.

2 Safety



When operating the device, comply with the following safety instructions as well as those contained in subsequent chapters. Use the device only for the purpose specified in these instructions. Failure to comply with the safety instructions can result in injury and/or damage to the device.

Qualified personnel

- As with the preceding instrument decontamination, the sterilization of instruments and textiles using this steam sterilizer may only be carried out by competent personnel.

Set-up, installation and commissioning

- Check the device for any damage suffered during transport after unpacking.
- The device should only be set-up, installed and commissioned by MELAG authorized persons.
- The connections for electrical provision and water supply and effluent must be set-up by trained personnel.
- Use of the optional leak detector (water stop) minimizes the risk of water damage.
- In accordance with current VDE specifications, the device is unsuitable for operation in explosive atmospheres.
- Install and operate the device in a frost-free environment.
- The device is conceived for use outside the patient area. The device should be located a minimum of 1.5 m radius away from the treatment area.
- The documentation media (computer, CF card reader etc.) must be placed in such a way that they cannot come into contact with liquids.
- Observe all the information contained in the technical manual during commissioning.

Power cable and power plug

- Comply with all legal requirements and locally-specified connection conditions.
- Never operate the device if the plug or power cable are damaged.
- The power cable and plug should only be replaced by authorized personnel.
- Never damage or alter the power plug or cable.
- Never unplug by pulling on the power cable. Always take a grip on the plug.
- Ensure that the power cable does not become jammed in.
- Never lead the cable along a source of heat.
- Never fix the power cable with sharp objects.

Decontamination and sterilization

- Follow the manufacturer instructions of your textile articles and instruments regarding their decontamination and sterilization.
- Observe the relevant standards and directives for the decontamination and sterilization of textiles and instruments, e.g. RKI [Robert Koch Institute] and DGSV [German Society for Sterile Supply].
- Only ever use packaging material and systems which have been approved by their manufacturer for steam sterilization (consult the manufacturer's instructions).

Program termination

- Please observe that depending on the time of the program abort, opening the door following a program abort can lead to hot steam leaving the chamber.
- Depending on the time of the program abort, it is possible that the load is unsterile. Observe the clear instructions shown on the display of the steam sterilizer. If necessary, sterilize the affected objects after rewrapping.

Removing the sterilized equipment

- Never use force to open the door.
- Use a tray jack to remove the tray. Never touch the sterilized items, the chamber or the door with unprotected hands. The components are hot.
- Check the packaging on the sterilized equipment for damage when removing it from the steam sterilizer. Should the packaging be damaged, re-pack the sterilization material and re-sterilize it.

Transport and storage

- Store and transport the device in a frost-free environment.
- The device should always be carried by two people.
- Use suitable carrying straps to carry the device.

Maintenance

- Have the maintenance done only by authorized persons.
- Maintain the specified servicing intervals.
- Only original MELAG spare parts may be used.

Malfunctions

- Should the device issue the same malfunction message repeatedly, turn off the device and if necessary, inform your stockist.
- Only have the device repaired by authorized persons.

3 Performance specifications

Intended use

The steam sterilizer is designed for use in a general medical environment in which the instruments used and their packaging do not require a class B steam sterilizer.

According to DIN EN 13060, this steam sterilizer is a Class S sterilizer. As a universal steam sterilizer, it is suitable for the sterilization of unwrapped or wrapped solid instruments, hollow body articles and smaller quantities of textiles.



WARNING

Any attempt to sterilize liquids can result in a delay in boiling. This can result in damage of the steam sterilizer and burns.

- Never use this steam sterilizer to sterilize any fluids. It is not licensed for the sterilization of fluids.
-



NOTICE

Failure to comply with these safety instructions can result in damage or can compromise safety.

- Only ever use the steam sterilizer for the applications as foreseen in the technical documentation and only in connection with the devices and components as recommended by MELAG.
 - As with the preceding instrument decontamination and in accordance with §2 MPBetreibV, the sterilization of instruments and textiles using this steam sterilizer may only be carried out by competent personnel.
 - When conducting sterilization procedures, only use instruments, packaging and textiles which the manufacturer has cleared for steam sterilization.
-

Sterilization procedure

The steam sterilizer sterilizes on the basis of the fractionated flow procedure.

This guarantees the complete and effective wetting/penetration of the sterilization material with saturated steam.

The steam sterilizer uses integrated steam generation to generate sterilizing steam. Steam is generated in the sterilization chamber upon program start. This establishes a pre-defined pressure and a set temperature. The sterilization chamber is protected against overheating. You can sterilize instruments or textiles directly one after each other, thereby achieving excellent drying results.

Automatic preheating

Activation of the preheating function pre-heats the cold chamber or holds it at a specific temperature between two sterilization runs. This reduces program times and reduces the accretion of condensation, thus improving drying results.

Type of the feed water supply

The steam sterilizer works with both a one-way feed water system and following the feed water circulation system. The one-way feed water system uses fresh demineralized or distilled feed water for every sterilization procedure. The quality of the feed water is subject to permanent monitoring via integrated conductivity measurement. If combined with instrument decontamination of the instruments, this serves largely to prevent stain accretion on the instruments and soiling of the steam sterilizer. When using the feed water circulation system, the steam sterilizer saves water, as the feed water is used for multiple sterilization cycles. The quality of the feed water is subject to permanent monitoring via integrated conductivity measurement.

Automatic feed water supply

The supply with feed water for steam generation is performed automatically via an internal storage tank or a water treatment unit (e.g. MELAdem 40, MELAdem 47). The technical manual provides detailed information regarding connection to a water treatment unit.

Safety equipment

Internal process monitoring

An process evaluation system is integrated in the electronics of the steam sterilizer. It compares the process parameters (such as temperature, time and pressure) during a program run. It monitors the parameters in terms of their threshold values during control and regulation and guarantees safe and successful sterilization. A monitoring system checks the device components of the steam sterilizer for their functionality and their plausible interaction. If one or more parameters exceeds pre-determined threshold values, the steam sterilizer issues warning or malfunction messages and if necessary, aborts the program. In the case of a program abort, follow the instructions on the display.

The steam sterilizer uses an electronic parameter control. This enables the steam sterilizer to optimize the total operating time of a program in dependence on the load.

Door mechanism

The steam sterilizer constantly checks pressure and temperature in the sterilization chamber and prevents the door from being opened when over-pressure has built up in the chamber.

Quantity and quality of the feed water

The quantity and quality of the feed water is automatically checked before every program start.

Overview of the sterilization programs

The results in this table show which inspections were performed on the steam sterilizer. The marked fields demonstrate compliance with all the applicable sections of the standard DIN EN 13060.

Table 1: Overview of the sterilization programs

Type tests	Universal-Program	Quick-Program S	Gentle-Program	Prion-Program
Program type in accordance with DIN EN 13060	Type S	Type S	Type S	Type S
Dynamic pressure test of the sterilization chamber	X	X	X	X
Air leak	--	--	--	--
Empty chamber test	X	X	X	X
Solid load	X	X	X	X
Porous partial load	X	--	X	X
Porous full load	--	--	--	--
Simple hollow body articles	X	X	X	X
Product with narrow lumen	--	--	--	--
Single wrapping	X	--	X	X
Multiple wrapping	X	--	X	X
Drying solid load	X	X	X	X
Drying, porous load	X	--	X	X
Sterilization temperature	134°C	134 °C	121 °C	134 °C
Sterilization pressure	2.1 bar	2.1 bar	1.1 bar	2.1 bar
Sterilization time	5:30 min.	3:30 min.	20:30 min.	20:30 min
X = Complies with all applicable sections of the standard DIN EN 13060				

Program sequences

Regular sterilization program

After program start, you can follow the program run on the display. It shows the chamber temperature and pressure as well as the time until the end of sterilization / the drying.

Table 2: Phases of a sterilization program

Program phase	Description
1. Air removal phase	The fractionated flow procedure removes the air from the chamber through pulsing repeated steam injection and removal. Depending on the program selected and the current chamber temperature upon program start, further fractionation can also follow.
2. Heating phase	The heating phase follows the air removal phase. The pressure and temperature increase until the program-specific sterilization parameters have been reached.
3. Sterilization phase	If the pressure and temperature correspond to the program-dependent nominal values, the sterilization phase begins. The sterilization time is indicated on the display.
4. Pressure release	The end of the sterilization phase is followed by pressure release with simultaneous emptying.
5. Drying phase	The drying phase begins after the pressure release.

Overview of programs

MAIN menu

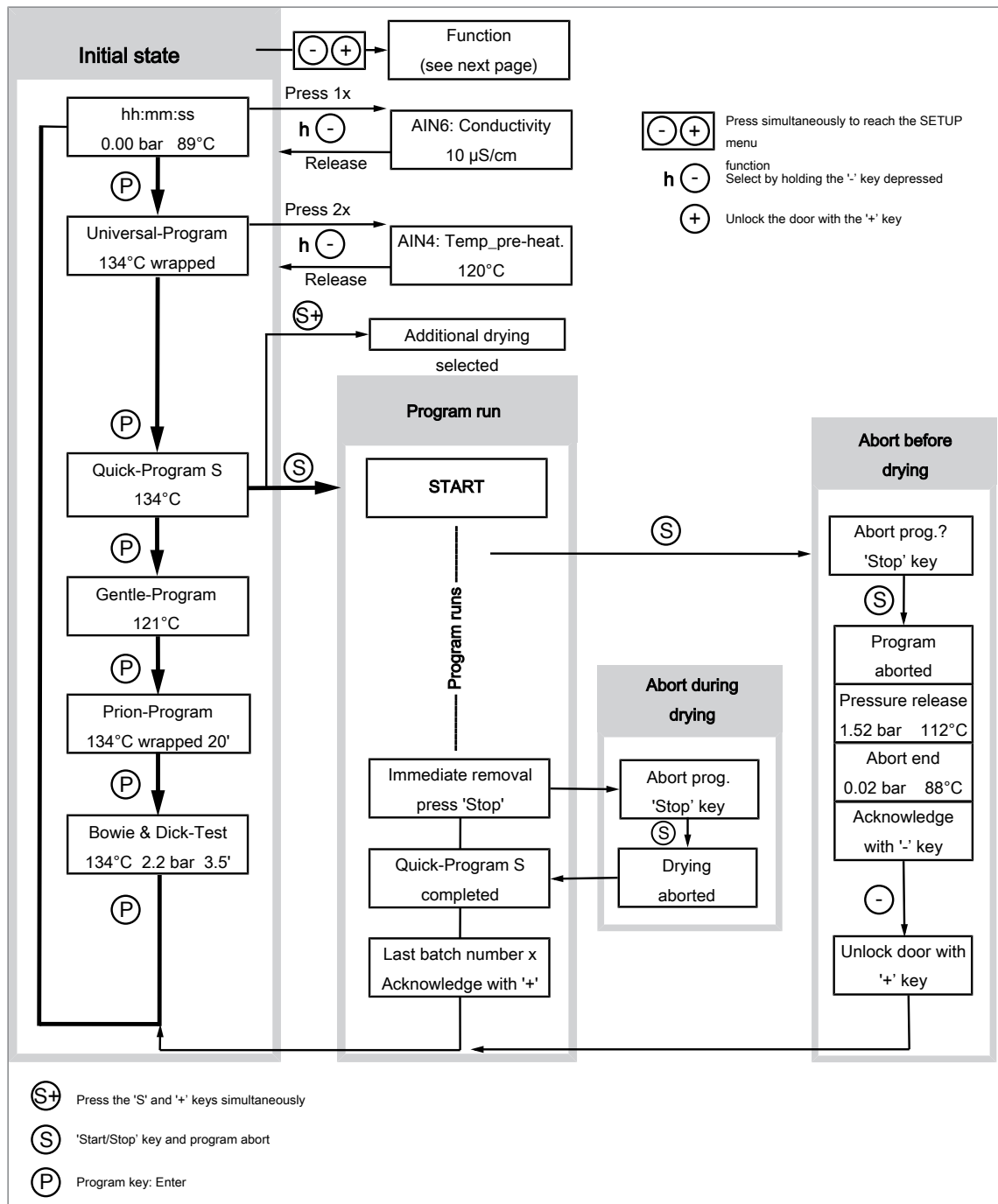

Functions of the SETUP menu

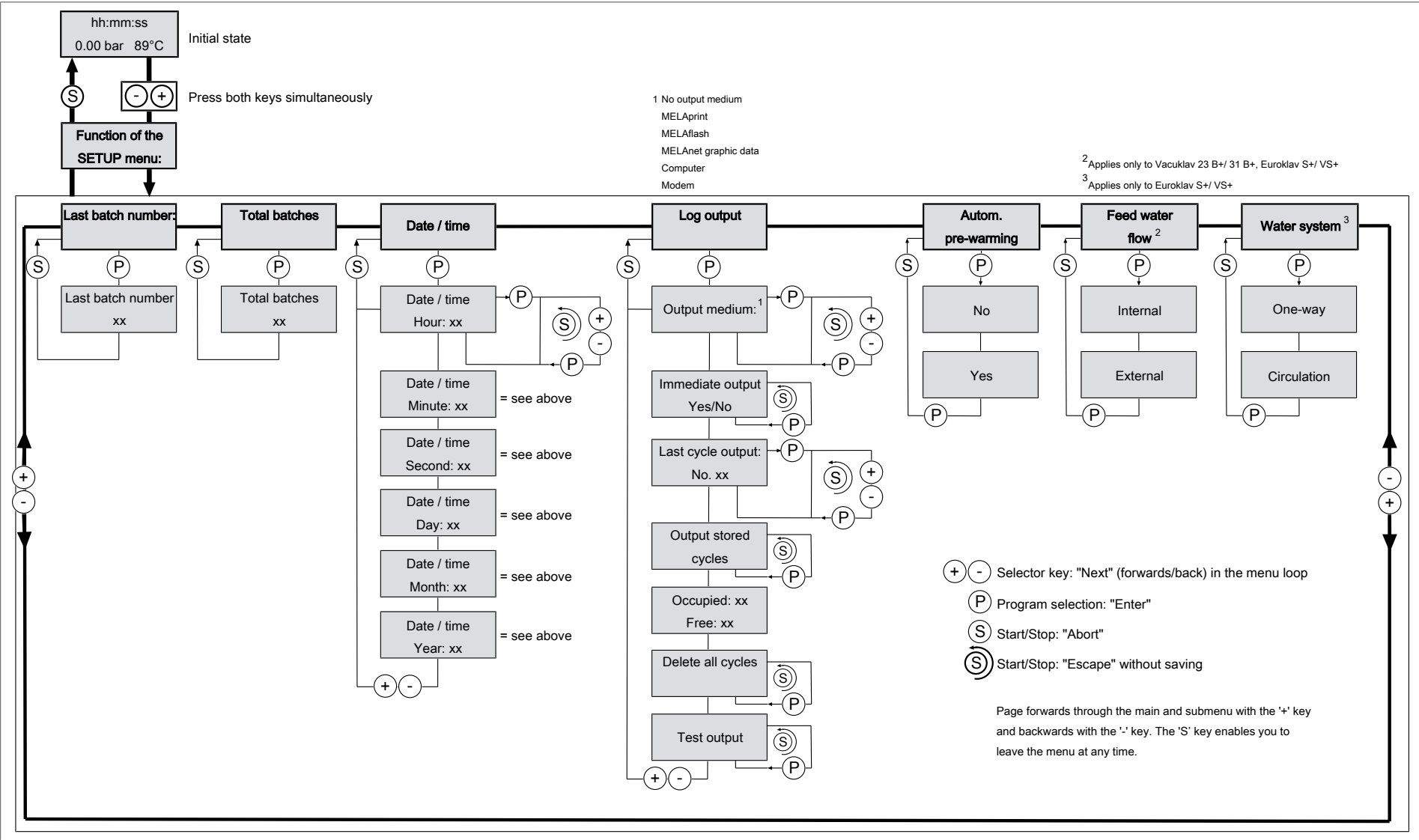

4 Description of the device

Scope of delivery

Please check the scope of delivery before setting up and connecting the device.

Standard scope of delivery

- Euroklav 23 S+
- User manual
- Technical manual
- Usage instructions for the mounts
- Warranty certificate
- Manufacturer's inspection report and declaration of conformity
- Record of installation and setup
- Mount for trays and cassettes
- Hose for emptying the interior storage tank
- TORX key for removing the carrying strap
- Key for the "flow" chamber filter
- Lever for emergency release of the door
- 2x replacement device fuses on the inside of the door of the steam sterilizer
- Tray lifter

Optional

- Trays
- Water treatment unit
- Standard tray cassettes and lifter
- Additional mounts
- MELAprint 42/44 log printer
- MELAflash CF card printer with CF card and card reader
- MELAnet Box

Views of the device

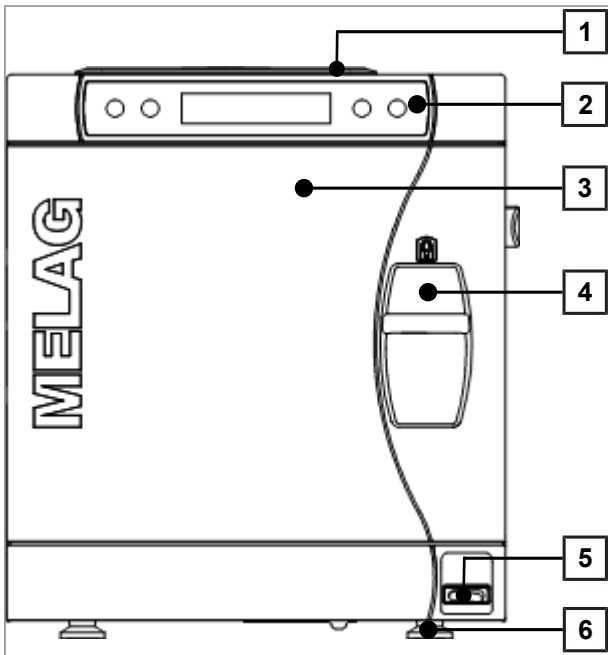

Fig. 1: Front

- 1 Tank lid
- 2 Operating and display panel
- 3 Door, swings open to the left
- 4 Slide seal grip
- 5 Power switch
- 6 Front device foot (adjustable)

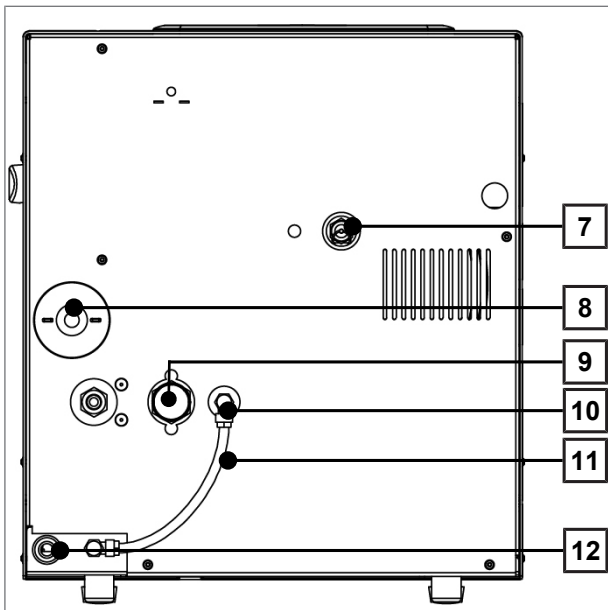

Fig. 2: Rear panel

- 7 Spring safety valve
- 8 Sterile filter
- 9 One-way discharge
- 10 Feed water inflow via the internal storage tank
- 11 Hose bridge for internal feed water supply
- 12 Power cable

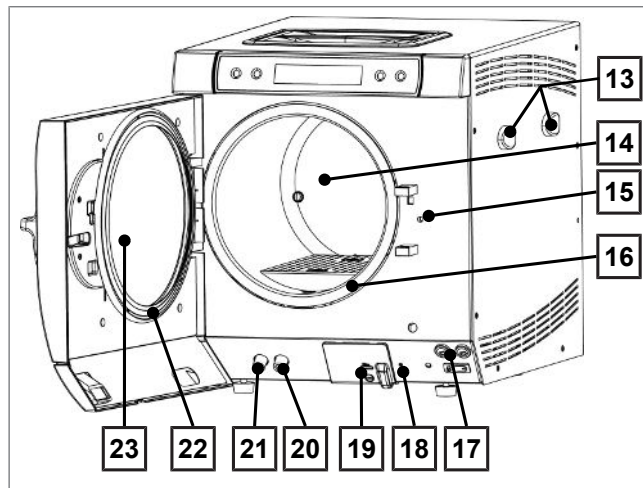
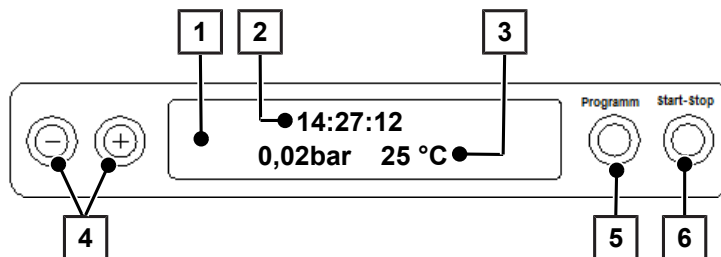

Fig. 3: View of the interior

- 13 Fixing for MELAdem 40
- 14 Chamber
- 15 Door locking pin
- 16 Chamber sealing face
- 17 2x device fuses
- 18 Overheat control reset button
- 19 Serial data and printer connection (RS232)*
- 20 Connection for emptying the storage tank - feed water
- 21 Connection for emptying the storage tank - wastewater
- 22 Door seal
- 23 Round blank
- *) Concealed by the cover

Operating panel

The operating panel consists of a two-row alphanumerical LC display and four membrane keys.



- 1 **2-row LC display**
for display of the program status and parameters
- 2 Time (h:min:s)
- 3 Chamber pressure (bar) and (steam) temperature (°C)
- 4 **Function keys '-' and '+'**
for the selection, setting and display of special functions: Press, date / time, pre-warming, total batches, conductivity, acknowledge malfunction, '+' key for unlocking the door
- 5 **Program selection key 'P'**
for selecting the sterilization program / test program and selection / setting of the options (submenus) of the special functions
- 6 **Start – Stop key 'S'**
for starting programs, aborting programs / drying and controlling the special functions

Initial state

The display switches to the initial state after every activation of the device. This displays the current time, the chamber pressure in bar and the (steam) temperature in °C.

Load mounts

The steam sterilizer is always delivered with a mount for holding trays or cassettes. Detailed information regarding the various mounts, their combinability with various load holders and their application can be found in the operating manual "Usage instructions for mounts".

Mount A "Plus"

The mount (A "Plus") is standard and can accommodate either five trays or three standard tray cassettes when turned 90°.

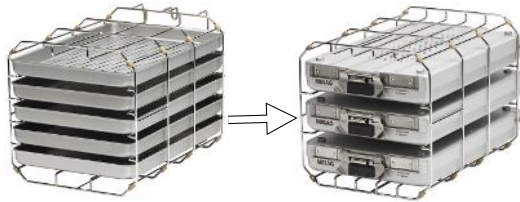

Mount B

The mount (B) can accommodate four standard tray cassettes or four trays.



Mount D

The mount (D) can accommodate two high cassettes (e.g. implant cassettes) or four trays (if turned 90°).



5 First steps

Setup and installation



PLEASE NOTE

Comply with the specifications of the technical manual during set-up and installation. This contains all building-side requirements.

Record of installation and setup

The record of installation is to be completed by the responsible stockist and a copy sent to MELAG as proof of the correct set-up, installation and initial commissioning. This is a constituent part of any guarantee claim.

Feed water supply

Steam sterilization requires the use of distilled or demineralized water water, known as feed water. DIN EN 13060 requires that feed water be used in accordance with the guideline values in appendix C.

The feed water supply is effected either via the internal feed storage tank or via a separate water treatment unit (e.g. MELAdem 40/MELAdem 47). When using the internal storage tank for the feed water supply, it is necessary to refill it periodically. The steam sterilizer will issue notification at the relevant time. The internal storage tank holds 5 L and is sufficient for up to 7 sterilization runs in a one-way system. The used feed water, so called wastewater is either collected in the internal storage tank on the wastewater side (left) and emptied manually or disposed of automatically via a building-side wastewater connection.

A water treatment unit is connected to the domestic water supply. It produces the feed water which the steam sterilizer requires for steam generation. The use of a water treatment unit guarantees the availability of sufficient feed water. There is no need to fill the feed water container manually.

Using the internal water storage tank

When feed water is supplied via the internal storage tank, this needs to be filled manually from time to time. The steam sterilizer will issue notification at the relevant time.

The internal storage tank holds max. 5 litres. This volume of feed water is sufficient for up to seven sterilization runs.

The feed water supply must be switched on. The steam-generating system requires at least one litre of water.

- ▶ To fill the storage tank with fresh feed water remove the lid and fill the right-hand chamber of the storage tank with fresh feed water up to the MAX mark.

Setting the feed water supply on the steam sterilizer

The **INTERNAL** function must be set in order to enable feed water supply via the internal storage tank. The **EXTERNAL** function must be set in order to enable feed water supply via a water treatment unit.

1. Select the SETUP menu **Function** by pressing the '+' and '-' keys simultaneously. The display shows **Function: Last batch number**
2. Navigate using the '+' or '-' keys until the display shows: **Function: Feed water supply**.
3. Press the 'P' button. The display shows the option currently set.
4. Press the 'P' key again to change to the desired setting (**INTERNAL** / **EXTERNAL**).
5. Press the 'S' key to save the setting and to leave the menu.

Repeated pressing of the 'S' key enables you to leave the menu entirely and return to the display basic state.

Wastewater connection

The wastewater can either be collected in the internal storage tank on the wastewater side (left) and be removed manually or be let out automatically via the one-way drain. An upgrade kit can be ordered to connect the steam sterilizer to the wastewater. Detailed information regarding the connection to the wastewater is provided in the technical manual.

Switching on the steam sterilizer

✓ *The steam sterilizer is connected to the electricity supply.*

▶ The steam sterilizer is switched on at the power switch.

The display alternates between the initial state and the notification **Unlock door with '+' key**, if the door is closed.



PLEASE NOTE

All accessories must be removed from the chamber directly after the steam sterilizer has been switched on for the first time and before initial commissioning.

After device activation, a heating up time of c. 5 minutes is required. A program will be started only after the target temperature has been reached.



PLEASE NOTE

When switching off the device via the power switch, wait three seconds before switching it back on.

Opening and closing the door

The door can only be opened when the display shows: **Acknow. with '+' key / Unlock door with '+' key**.

1. Press the '+' key. You can open the door after hearing an audible click.
2. To shut the door, press it against the chamber flange and slide the locking slider downwards to its at the same time.

Setting the date and time

Correct batch documentation requires the correct date and time setting on the steam sterilizer. Ensure that you take into account the clock change in autumn and summer, as this is not adjusted automatically. Set the date and time as follows:

1. Select SETUP menu **Function** by pressing the '+' and '-' keys simultaneously. The display will show **Function: Last batch number**.
2. Navigate in the **Function** menu using the '+' or '-' keys until the display shows:

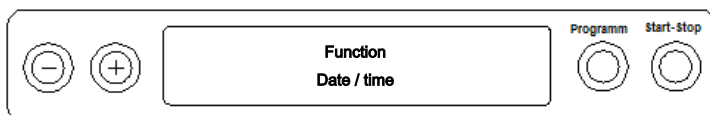

3. Press the 'P' key to confirm. The current hour is displayed.
4. Choose one of the following setting possibilities using the '+' or '-' keys: hour, minute, second, day, month, year.
5. To e.g. adjust the hours parameter, press the 'P' key to confirm. The current value flashes on the display.
6. You can increase or reduce the value using the '+' and '-' keys.

7. Confirm with the 'P' key to save.
The current value set no longer flashes on the display.
Proceed in a similar fashion to alter the other parameters.
8. After ending the settings, press the 'S' key to leave the menu.
The display will show **Function: Date / Time**.
9. Repeated pressing of the 'S' key enables you to leave the menu and the display returns to its basic state.

6 Loading the steam sterilizer

Preparing the sterilization material

Cleaning and disinfection must always have been performed before sterilization. Only in this way is it possible to guarantee the subsequent sterilization of the sterilization material. The materials used, the cleaning fluid and treatment procedures used are of decisive significance.



NOTICE

Only ever operate the steam sterilizer with a sterile filter inserted.

Decontaminating textiles



WARNING

The incorrect decontamination of textiles, e.g. a textile package can prevent steam penetration and/or produce poor drying results. The textiles could not be sterilized.

This could endanger the health of patient and practice team.

Please comply with the following points when treating textiles and putting the textiles in sterilization containers:

- ▶ Comply with both the manufacturer's instructions of the textiles regarding treatment and sterilization as well as the relevant standards and directives e.g. from the RKI and DGSV.
- ▶ Arrange the folds in the textiles parallel to each other.
- ▶ Stack textiles vertically wherever possible and not too closely together in the sterilization container. This enables the development of flow channels.
- ▶ Retain the vertical stacking system when packing textiles in the sterilization container.
- ▶ If textile packages do not remain together, wrap the textiles in sterilization paper.
- ▶ Only ever sterilize dry textiles.
- ▶ The textiles may not be permitted to come into direct contact with the sterilization chamber; otherwise they will become saturated with condensate.

Decontaminating the instruments



WARNING

The incorrect decontamination of instruments could result in any dirt residue being loosened by the steam pressure during sterilization.

The use of unsuitable care agents e.g. water repellent agents or oils impermeable to steam could result in unsterile instruments. This represents a danger to the health of both patients and yourself.



NOTICE

The presence of residual disinfection and cleaning fluids results in corrosion.

This could result in increased maintenance requirements and a restriction of the steam sterilizer function.

Please ensure the following when treating used and brand-new instruments:

- ▶ Follow both the instrument manufacturer's instructions regarding decontamination and sterilization and comply with the relevant standards and directives e.g. from the BGV A1, RKI and DGSV.
- ▶ Clean the instruments exceptionally thoroughly e.g. using an ultrasonic device or washer-disinfector.
- ▶ Rinse the instruments after washing and disinfecting, where possible with de-mineralized or distilled water and then dry the instruments thoroughly with a clean, non-fuzzing cloth.
- ▶ Use only those care agents suitable for steam sterilization. Consult the manufacturer of the care agents. Do not use any water repellent agents or oils impermeable to steam.
- ▶ When using ultrasound devices, care equipment for handpieces and washer-disinfectors, please comply with the manufacturer's treatment instructions.

Loading the steam sterilizer

Effective sterilization and good drying is only possible if the steam sterilizer has been loaded correctly.

Ensure the following during loading:

- ▶ Insert trays or cassettes in the chamber only with their appropriate mount.
- ▶ Use perforated trays such as those from MELAG. Only in this way can condensate drain off. The use of a non-perforated base or half-shell to accommodate the sterilization material can result in poor drying results.
- ▶ The use of paper tray inserts can also result in poor drying results.
- ▶ Wherever possible, please ensure the separate sterilization of textiles and instruments in separate sterilization containers or sterilization packaging. This leads to better drying results.

Packaging

Only ever use packaging materials and systems (sterile barrier systems) which fulfil the standard DIN EN ISO 11607-1. The correct use of suitable packaging is important in achieving successful sterilization results. You can use re-usable rigid packaging systems such as e.g. standard tray cassettes or soft packaging such as transparent sterilization packaging, paper bags, sterilization paper, textiles or fleece.

Closed sterilization containers



CAUTION

The use of unsuitable sterilization containers results in insufficient steam penetration and even failure of the sterilization. This can also prevent condensate drain-off.

This produces poor drying results. This can result in unsterile instruments and thus endanger the health of patient and practice team.



CAUTION

Incorrect stacking of the sterilization containers can result in the dripping condensate being unable to drain off to the chamber floor. This can saturate sterilization material directly underneath it.

This produces poor drying results. This can result in unsterile instruments and thus endanger the health of patient and practice team.

- Do not cover the perforations when stacking the sterilization containers.

Please comply with the following when using closed sterilization containers for sterilization material:

- ▶ Use aluminium sterilization containers. Aluminium retains and conducts heat and thus accelerates drying.
- ▶ Closed sterilization containers must be either perforated or have a valve on at least one side - optimally the bottom. MELAG sterilization containers fulfil the requirements for successful sterilization and drying.

- ▶ The perforations of one-sided perforated sterilization containers should be at the top of any containers such as with MELAstore-Boxes.
- ▶ Wherever possible, please ensure that sterilization containers are only stacked on top of those of identical size, so that the condensate can run down their sides.
- ▶ Ensure that the perforations are not covered when stacking the containers.

Tip: MELAG sterilization containers fulfil the requirements of DIN EN 868-8 for successful sterilization and drying. They have a perforated lid and base and are fitted with disposable paper filters.

Soft sterilization packaging

Soft sterilization packaging can be used in both sterilization containers and on trays. Please comply with the following when using soft sterilization packaging e.g. MELAfol:

- ▶ Arrange soft sterilization packaging in a perpendicular position and at narrow intervals.
- ▶ Do not place multiple soft sterilization packages flat on top of each other on a tray or in a container.
- ▶ If the seal seam tears during sterilization, the packaging could be too small or the sealing pulse too low. Re-pack the instruments and if necessary, extend the sealing pulse on the film sealing device or make a double seam. Sterilize the sterilization material again.

Multiple wrapping

The steam sterilizer works with a fractionated flow procedure. This permits the use of multiple packaging.

Mixed loads

Please observe the following when sterilizing mixed loads:

- ▶ Always place textiles at the top.
- ▶ Place the sterilization containers at the bottom.
- ▶ Place unwrapped instruments at the bottom.
- ▶ Place the heaviest loads at the bottom.
- ▶ Place transparent sterilization packaging and paper bags at the top - except in combination with textiles. In this case, place them at the bottom.
- ▶ Place transparent sterilization packages on their edge wherever possible and with the paper side facing downwards.

Loading versions

Table 3: Example: Loading versions

Loading versions ^{*)}	Instruments / textiles
Max. weight per piece	2 kg / 0.6 kg
Maximum total weight ^{**)}	4 kg / 0.6 kg
^{*)} MELAG mounts, trays, sterilization containers, standard tray cassettes, see Accessories and spare parts [▶ page 57].	
^{**)} The specifications for the solid loads (e.g. instruments) include the weight of mounts, trays, sterilization containers and standard tray cassettes. The specifications for the porous loads (e.g. textiles) do not include the weight of mounts, trays, sterilization containers and standard tray cassettes.	

Loading patterns designed especially for the dental sector are available from the download area of the MELAG website: www.melag.com.

7 Sterilization

Selecting the program

You can switch between the initial state and the desired program using the program selection switch 'P'.

Now select the sterilization program according to how and whether the sterilization material is packed. It is also necessary to take into account the temperature resistance of the sterilization material.

The following table shows which program is to be selected for which sterilization material.

Table 4: Overview of the sterilization programs

	Universal-Program	Quick-Program S	Gentle-Program	Prion-Program
Sterilization temperature	134 °C	134 °C	121 °C	134 °C
Sterilization pressure	2.1 bar	2.1 bar	1.1 bar	2.1 bar
Sterilization time	5:30 min.	3:30 min.	20:30 min.	20:30 min.
Operating time ^{*)}	c. 25 min.	c. 15 min.	c. 40 min.	40 min.
Drying	25 min.	c. 10 min.	25 min.	25 min.

^{*)} without drying, depending on the load (full load Euroklav 23 S+: 4 kg) and installation conditions (such as supply voltage)

Table 5: Overview of the use of the respective sterilization programs

Program name	Packaging	Especially suitable for	Load ^{*)}
Universal-Program	Single and multiple wrapping	Mixed loads; transmission instruments, simple hollow bodies	4 kg
Quick-Program S	Only unwrapped (no textiles)	Single massive instruments; simple hollow bodies	4 kg
Gentle-Program	Single and multiple wrapped	Textiles; thermo-unstable items (e.g. plastic, rubber articles)	Textiles 0.6 kg Thermo-unstable equipment 4 kg
Prion-Program	Single and multiple wrapped	Instruments under suspicion of carrying the danger of infection through abnormally altered proteins (e.g. Creutzfeld-Jacob, BSE) ^{**)}	4 kg

^{*)} This applies massive loads (e.g. instruments) including the weights of mounts, trays, sterilization containers and standard tray cassettes. This applies porous loads (e.g. textiles) excluding the weights of mounts, trays, sterilization containers and standard tray cassettes.

^{**)} Please notice your national regulations of your country

Additional program options

Selecting automatic pre-heating

Automatic preheating is activated in delivery state. This function heats the steam sterilizer chamber to a preheating temperature of the respective programme before program start, or holds this temperature between two program runs. This will shorten the cycle times. It also reduces condensate formation on the chamber wall.

 **PLEASE NOTE**

The steam sterilizer must remain continually activated for the automatic preheating.

To alter this setting proceed as follows:

1. Select SETUP menu **Function**. By pressing the '+' and '-' keys simultaneously until the display shows **Function: Last batch number**. Navigate using the '+' or '-' key until the display shows:

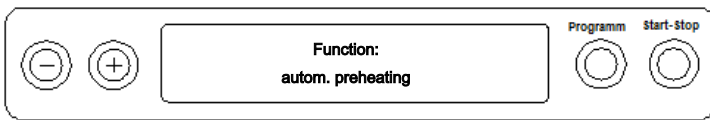

2. Press the 'P' key to confirm. The display will show the option currently set e.g. **Preheating YES**.
3. Pressing the 'P' key again makes the display switch to **Preheating NO**. The preheating function has been deactivated.
4. To close the **Function: Autom. preheating** menu and to return to the initial state, press the (S) key twice.

 **PLEASE NOTE**

MELAG recommends activating the automatic preheating function.

Selecting additional drying

The **Additional drying** function extends the drying time by 50 % to perform difficult drying tasks.

- ▶ Press the 'S' and '+' keys simultaneously upon starting the program. The display will show:

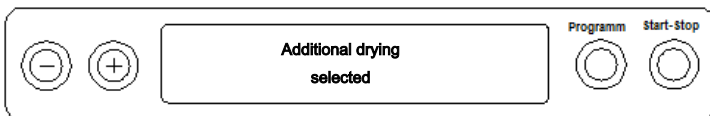

The program run will now begin.

Starting the program

 **NOTICE**

Unsupervised operation of electrical devices, including this steam sterilizer at the operator's risk. MELAG accepts no liability what so ever for any damage resulting from unsupervised operation.

After having selected a program via the program selection key 'P', the display will show both the selected program and sterilization temperature as well as whether the program is suitable for wrapped or

unwrapped sterilization material.

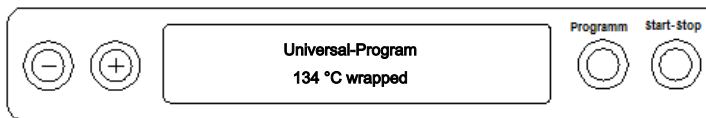

- ▶ Press the 'S' key to start the program.
The steam sterilizer checks the feed water supply and its conductivity.



PLEASE NOTE

If the Quick-Program S has been started, the warning **Attention: Unwrapped instruments only** appears on the display.

If the load contains exclusively unwrapped instruments, press the 'S' key again to confirm and to start the program.

Program run

After starting the program, you can follow the program run in the display. It shows the chamber temperature and pressure as well as the time until the end of sterilization / the drying time which has passed.

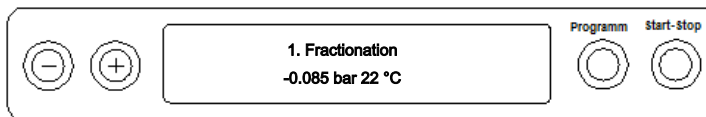

Sterilization phase

The display enables you to see whether the sterilization phase has already been completed successfully. The remaining time of the sterilization phase is displayed in alternation with pressure and temperature specifications.

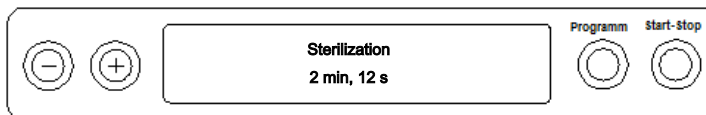

Drying phase

The regular drying time of the Quick-Program S amounts to c. 10 min. For all other programs, it is 25 minutes. The display will show the corresponding message during the drying phase.

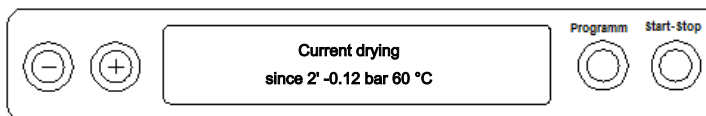

The steam sterilizer provides excellent drying of the sterilization material. If difficult-to-dry items require better drying, you can undertake the following steps to improve drying:

- ▶ Load the steam sterilizer properly. Stand e.g. the transparent and paper sterilization packaging upright. Observe the contents of the section [Loading the steam sterilizer](#) [▶ page 22]. Use the optional package holder if necessary.
- ▶ Activate the **Additional drying** function. Comply with the specifications of section [Selecting additional drying](#) [▶ page 25].

Program end

When the program has been completed successfully, the display shows:

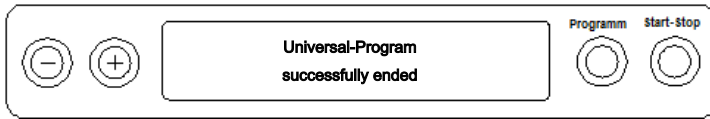

Working in SETUP menu **Function** under **Last batch number** if immediate output after program end is activated, the log of the completed program will be outputted to the activated output medium after opening the door, see Logging.

Manual program abort

You can abort a current program in all phases. If you end the program before drying begins, the sterilization material remains **unsterile**.

Program abort before the start of drying



WARNING

Danger of infection from early program abort

Aborting a program before the drying phase begins means that the load is unsterile. This endangers the health of your patients and practice team.

- If necessary, repack the load and repeat the sterilization for the sterilization material affected.

Proceed as follows to abort the program during drying:

1. Press the 'S' key.
2. Confirm the following security query **Stop program?** by pressing the 'S' key repeatedly.



PLEASE NOTE

The security query will be shown on the display for approx. 5 seconds. If the 'S' key is not pressed repeatedly, the program will continue with the usual program run.

Depending on the time of the abort, pressure will be released or the device will be ventilated. A corresponding display text appears on the display.

After pressure release or ventilation, you will be asked to clear the program abort.

The display will alternate between **Stop / End** and **Acknowledge with '-' key**.

3. Press the '-' key.
 - ➔ The display will alternate between **Unlock door with '+' key** and the program previously selected.
4. You can open the door after pressing the '+' key.

The log will contain: **Program stopped/ Load not sterile!**

Program abort after the start of drying

You can abort the program during the drying phase via the 'S' key without the steam sterilizer registering a fault.

Should you abort a program after drying has started, the sterilization is having been completed successfully. The steam sterilizer will not issue a malfunction message. You should expect insufficient drying, especially in the case of wrapped sterilized equipment and a full load. Sterile storage requires sufficient drying. To ensure this, please allow programs with wrapped sterilized equipment to continue to

the end of the drying phase as far as is possible. Unwrapped instruments sterilized in a Quick-Program dry after being removed from their own warmth.

The drying time completed thus far is indicated on the display during the drying phase. This will alternate with the display of:

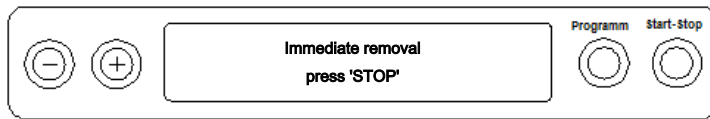

Proceed as follows to abort the program during drying:

1. Press the 'S' key.
2. Confirm the following security query **Immediate removal 'Stop'** by pressing the 'S' key repeatedly.

The display confirms the abort with Drying interrupted.



PLEASE NOTE

The security query will be shown on the display for approx. 5 seconds. If the 'S' key is not pressed repeatedly, the program will continue with the usual program run.

After ventilation of the chamber, the display will show: **Universal-Program run successfully** in alternation with:

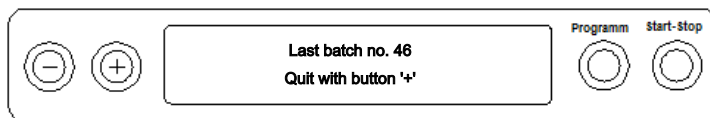

If a printer or other output media is connected to the steam sterilizer, and **Immediate output** is set to **YES**, the warning **Drying stopped** is recorded on the log.

Removing the sterilized equipment



CAUTION

Danger of burns from hot metal surfaces

- Allow the device to cool sufficiently before opening.
- Do not touch any hot metal parts.



CAUTION

Unsterile instruments resulting from damaged or burst packaging. This endangers the health of your patients and practice team.

- Should the packaging be damaged or have burst, re-pack the sterilization material and re-sterilize it.

If you remove the sterilized equipment from the device directly after the end of the program, it is possible that the instruments can be partially damp. According to the Arbeitskreis für Instrumentenaufbereitung (AKI; red brochure 11. Edition; p. 57): "In practice, residual moisture in the form of a few drops of water capable of evaporating within 15 minutes is tolerated, but actual pools of water are not acceptable."

Comply with the following specifications when removing the sterilized equipment:

- ▶ Never use force to open the door. This could damage the device and / or result in the emission of hot steam.
- ▶ Use a tray lifter to remove the tray.
- ▶ Never touch the sterilized equipment, the device interior or the inside of the the door with unprotected hands. The components are hot.

- ▶ Check the packaging on the sterilized equipment for damage when removing it from the device. Should the packaging be damaged, re-pack the sterilization material and re-sterilize it.

Storing sterile instruments

The maximum storage time is dependent on the packaging and the storage conditions. For standard-conform packaged sterilized equipment – (if protected from dust) it can amount to up to six months. Comply with the provisions of DIN 58953, part 8 and the criteria specified below for the storage of sterilized equipment:

- ▶ Comply with the maximum storage duration in accordance with the packaging type.
- ▶ Do not store the sterilized equipment in the decontamination room.
- ▶ Store the sterilized equipment in a dust-protected environment e.g. in a closed instrument cabinet.
- ▶ Store the sterilized equipment in a moisture-protected environment (e.g. alcohol, disinfectant).
- ▶ Store the sterilized equipment in an environment protected against excess temperature variations.

8 Logging

Batch documentation

The batch documentation acts as proof of the successful conclusion of the program and represents an obligatory part of quality assurance (MPBetreibV). The device internal log memory saves such data as the program type, batch and process parameters of all the programs completed.

To obtain the batch documentation, you can output the internal log memory and transfer its data to various output media. This can be performed immediately at the end of every program or at a later point, such as at the end of the day.

Capacity of the internal log memory

The capacity of the internal log memory is sufficient for 40 logs. If the internal log memory is full, the oldest log will be overwritten automatically at the beginning of the next program.

If a printer is connected and the option **Immediate output** has been set to **NO**, a security query will be issued before the saved log is overwritten. For further information about connecting the printer, consult the operating manual of the respective device.

Displaying the daily batch counter

The last batch number of the day is shown on the display after every program run.

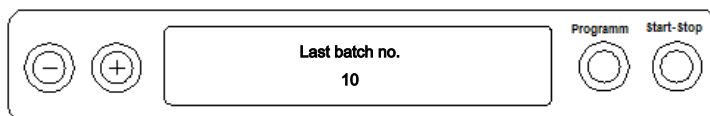

You can also arrange for the batch number to be displayed. To do so:

1. Select SETUP menu **Function** by pressing the '+' and '-' keys simultaneously. The display will show **Function: Last batch number**.
2. Press the 'P' key to display the current daily batch number.
3. To return to the basic state, press the 'S' key twice.

Displaying the total batch counter

You can arrange the display of the number of the batches previously run.

1. Select SETUP menu **Function** by pressing the '+' and '-' keys simultaneously. The display will show **Function: Last batch number**.
2. Navigate using the '+' or '-' keys until the display shows:

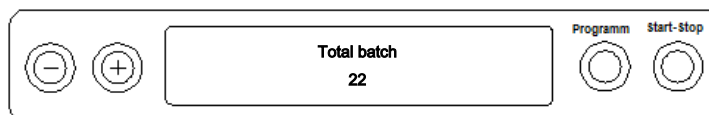

3. Press the 'P' key to display the current total batches counter.
4. To return to the basic state, press the 'S' key twice.

Output media

You are able to output and archive the logs of the completed programs on the following output media:

- MELAflash CF card printer on the CF card
- Computer, e.g. with MELAtrace/MELAview software
- MELAprint 42/44 log printer with network adapter

- MELAnet Box

In its delivery state, an option for log output is not set on the steam sterilizer.



PLEASE NOTE

Further information about the log printer (e.g. the duration of the readability of the log print-outs) is specified in the appendant operating manual.

Using a computer as an output medium (without a network connection)

In order to be able to use a computer as an output medium, the computer must be connected to the steam sterilizer via the serial interface.

You can connect the steam sterilizer to a computer if the following conditions are fulfilled:

- ✓ The computer is either fitted with a serial interface or a USB serial adapter is connected.
- ✓ The documentation software MELAview/MELAtace is installed on the computer.



PLEASE NOTE

The MELAnet Box is required for integration in the practice network..

1. Open the white cover (pos. 1) of the serial data and printer connection on the steam sterilizer.
2. To do so, insert a coin in the seal slot (pos. 2) in the white cover and tun a quarter of a revolution.
3. Remove the cover.
4. Push the metal frame downwards slightly until it unlocks and then fold the metal frame forwards. (pos. 3).
5. Connect the steam sterilizer to the RS232 interface to the computer with a fitting data connection cable.

The data connection cable can be laid in the cable duct (pos. 4) to ensure constant connection of the computer to the steam sterilizer. The metal frame can be folded in and the cover can be closed.

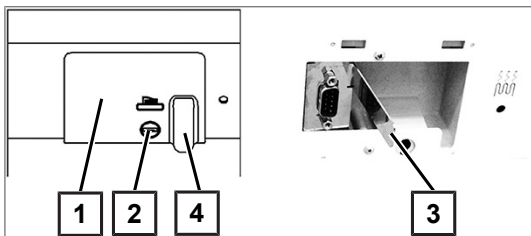

Fig. 4: Connection on the autoclave

Reading out a text log on the computer

You can use the MELAtace/MELAview software to read out the logs.

The following settings are required to register the computer on the steam sterilizer:

1. Switch on the steam sterilizer.
Wait until the display shows the initial state.
2. Select SETUP menu **Function** by pressing the '+' and '-' keys simultaneously. The display will show **Function: Last batch number**.
3. Navigate with the '+' or '-' keys in the **Function** menu until the display shows **Function: Log output**.
4. Press the 'P' key to select the **Log output – Output medium** submenu.
5. Press the 'P' key again. If an output medium has yet to be chosen, the display will show the **Log output – No output medium** notification.

Navigate using the '+' or '-' keys until the display shows:

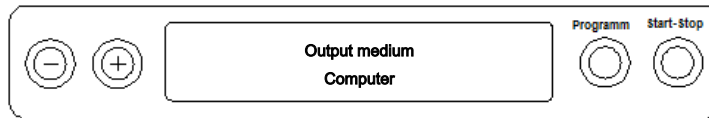

6. Press the 'P' key to confirm. The display switches back into the **Log output – Output medium** menu.
7. Press the 'S' key to return to the SETUP menu **Function: Log output**.
8. After repeated pressing of the 'S' key, the display returns to its initial state.

Opening a text log on the computer

All text logs can be opened and printed using a text editor, a word processing program or a spreadsheet program.



PLEASE NOTE

Graphic logs can only be displayed with the MELview (from MELview 3) / MELatrace documentation software.

Each text log (e.g. PRO, .STR, .STB etc.) must be linked with the text editor to enable the operating system of your computer to open them automatically with a text editor. The meanings of the endings are outlined in the section Subsequent log output. The following examples show how you can link the Windows 7 editor with a specific text log.

1. Working in Windows Explorer, double click on the log file.
2. If the file ending is unfamiliar, Windows 7 will display the following message:

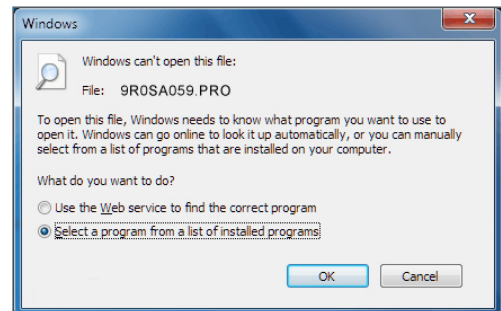

3. Select "Select a program from a list of installed programs" and confirm with "OK".

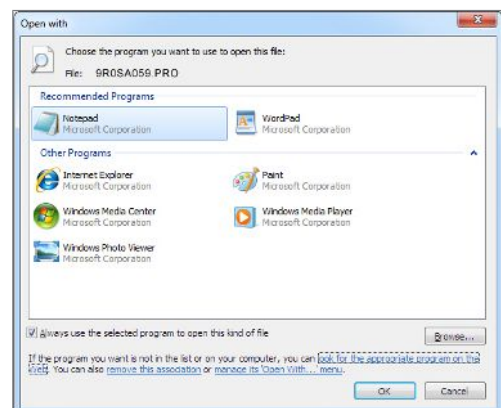

4. You can then open files with this ending via a double-click in Windows Editor.

Alternatively, you can open all text logs with the documentation software MELview (from MELview 3) / MELatrace.

Outputting logs immediately and automatically

Text log

If you want to output the associated text and graphic logs automatically after the end of a program on an output medium, use the function **Immediate output YES**. This is not set in the delivery state.

The following requirements must be fulfilled in order to issue logs immediately after the end of a program.

- ✓ In **SETUP** menu **Function**: *Log output immediate output is set to YES.*
- ✓ *At least one output medium must be selected (computer, log printer MELAprint 42/44).*
- ✓ *The activated output medium must be connected and initialized.*

1. Switch on the steam sterilizer at the power switch.
2. Select **SETUP** menu **Function** by pressing the '+' and '-' keys simultaneously. The display will show **Function: Last batch number**.
3. Navigate using the '+' or '-' keys. until the display shows: **Function: Log output** and press the 'P' key.
4. Navigate using the '+' or '-' keys until the display shows:

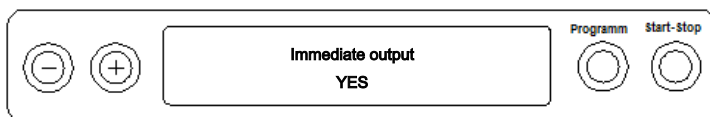

5. Press the 'P' key to change between **Immediate output NO / YES**.
6. Press the 'S' key to save the setting and to leave the menu. The display will show **Function: Log output**.
7. Pressing the 'S' key once again enables you to leave the menu and return to the display initial state.



PLEASE NOTE

If immediate output is unable to issue a log, for example, because the output medium activated is not connected, a warning will appear. MELAG recommends using the immediate log output function.

Subsequent log output

It is possible to output logs subsequently and independently of the time of the end of the program. You can choose whether selected or all saved logs (up to 40) are to be printed. Use the output medium connected for this task e.g. the log printer.

Printing selected logs

To print the subsequently selected logs of a particular program proceed as follows:

1. Select **SETUP** menu **Function** By pressing the '+' and '-' key simultaneously. The display will show the notification **Function: Last batch number**
2. Navigate using the '+' or '-' key until the display shows: **Function: Log output** and press the 'P' key. The **Log output – Output medium** menu is displayed.
3. Navigate using the '+' or '-' key until the display shows: **Last cycle output: no. 40** (as example no. 40).
4. Press the 'P' key. The current log number flashes.
5. To output a log or another cycle, navigate to the desired number using the (+) or (-) key until you have reached the following number. In this example, 25.
6. Press the 'P' key in order to start the output of the selected program. The display will show the notification **Output**.

After a successful output, the display returns to its previous setting and shows:

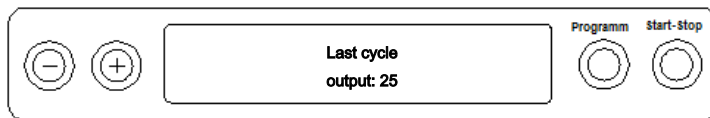

Repeat the last three steps in order to output further logs.

7. Press the 'S' key to leave the submenu without outputting the log.
8. Press the 'S' key to leave the menu after having outputted the log. The display will show the notification **Function: Log output**.
9. Repeated pressing of the 'S' key enables you to leave the menu entirely and return to the display initial state.

Outputting all saved logs

Proceed as follows to output all the saved logs subsequently:

1. Select SETUP menu **Function** By pressing the '+' or '-' key simultaneously. The display will show the notification **Function: Last batch number**
2. Navigate using the '+' or '-' key until the display shows: **Function: Log output** and press the 'P' key.
3. Navigate using the '+' or '-' key until the display shows:

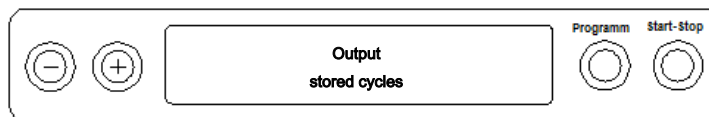

4. Press the 'P' key in order to start the output of the selected program. The display will show the notification **Output**.
 ↳ If output has been performed, the display will again show: **Output stored cycles**.
5. Press the 'S' key to leave the submenu without outputting the log.



PLEASE NOTE

An abort during log output on the log printer is only possible through deactivation of the device using the power switch or by interrupting the power supply to the printer.

When switching off the device via the power switch, wait three seconds before switching it back on.

6. Press the 'S' key to leave the menu. The display shows the notification of the SETUP menus **Function: Log output**.
7. Repeated pressing of the 'S' key enables you to leave the menu entirely and return to the display basic state.

Displaying the log memory

If a printer or other output medium is connected and initialized, you can check how many logs have already been saved in the steam sterilizer log memory.

Proceed as follows:

1. Select SETUP menu **Function** by pressing the '+' and '-' keys simultaneously. The display will show **Function: Last batch number**.
2. Navigate using the '+' or '-' keys until the display shows: **Function: Log output** and press the 'P' key.

3. Navigate using the '+' or '-' keys until the display shows the number of logs saved:

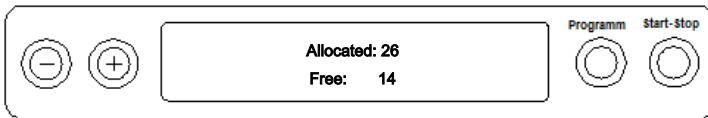

4. Press the 'S' key twice to leave the menu.

Deleting logs in the internal log memory

Delete the saved logs manually to suppress the warning **Protocol memory full** with the option **Immediate output NO** set. The following example shows how to delete all the logs saved.

1. Select SETUP menu **Function** by pressing the '+' and '-' keys simultaneously. The display will show **Function: Last batch number**.
2. Navigate using the '+' or '-' keys until the display shows: **Function: Log output** and press the 'P' key.
3. Navigate using the '+' or '-' keys until the display shows:

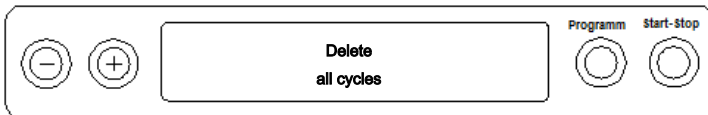

4. Press the 'P' key to delete all logs.
5. To cancel the submenu without deleting, press the 'S' key.
6. Press the 'P' key to leave the menu after deletion. The display will show **Function: Log output**.
7. Repeated pressing of the 'S' key enables you to leave the menu entirely and return to the display basic state.

Reading logs correctly

Log type	File ending	Explanation
Text log	.PRO	Log of a completed program
Malfunction log	.STR	Log of a program not completed
Graphic log	.GPD	Program run displayed as a graphic curve.
Standby log	.STB	Log for faults in standby
Demo log	.DEM	Protocols of a simulated program. No real sterilization will be performed!
Demo graphic log	.DEG	Simulated program run displayed as a graphic curve. no real sterilization will be performed!

Log header

The header of the program log comprises the general basic information regarding the program run. This includes e.g. date, the selected program, the daily batch number and the steam sterilizer type.

Program step values

The phases of the program run are recorded whilst it runs and the values for steam pressure, temperature and time (related to the program start) are recorded.

Summary

The summary states whether the program has been completed successfully. The values of the sterilization time required, the sterilization temperature and the pressure (including the maximum deviation) are also displayed.

----- MELAG Euroklav 235+ -----				HEADER	
Program	:	Universal-Program 134°C wrapped		started program	
Date	:	31.08.2018		current date	
Time	:	10:49:43 (Start)		time at program start	
Batch number	:	2		daily batch number	
SN	:	2018235+4321		serial number	

Preheating	:	120.0 °C		preheating temperature	
AIN6: Conductivity	:	0 µs/cm		conductivity of the feed water	

Program step		Press. bar	Temp. °C	Time min	VALUES OF THE PROGRAM STEPS
Start		0.00	99.6	00:00	
1. Fractionation					
Steam intake		1.00	120.5	00:48	
Press. release		0.20	104.7	01:27	
2. Fractionation					
Steam intake		1.00	120.5	02:06	
Press. release		0.20	104.7	02:45	
3. Fractionation					
Steam intake		1.00	120.5	03:23	
Press. release		0.20	104.7	04:02	
4. Fractionation					
Steam intake		1.00	120.5	04:41	
Press. release		0.20	104.7	05:20	
5. Fractionation					
Steam intake		1.00	120.5	05:59	program sequence phases with the accompanying values
Press. release		0.20	104.7	06:37	for pressure, temperature and time (relative to the program
6. Fractionation					start)
Steam intake		1.00	120.5	07:16	
Press. release		0.20	104.7	07:55	
Press. build-up		2.04	134.0	09:24	
Steriliz. begin.		2.04	134.0	09:24	
Steriliz. end		2.18	135.6	14:54	
Press. release		0.50	111.4	16:16	
Flow drying					
Drying begin.		0.50	111.4	16:16	
Drying flow		0.40	109.2	16:20	
Drying pumping		1.20	123.3	16:59	
Drying end		1.20	123.3	45:26	
End		0.00	99.6	46:17	

PROGRAM SUCCESSFULLY COMPLETED!				SUMMARY	
				control message	
Temperature	:	135.4 +0.3 /-0.3 °C		main sterilization temperature with max. deviations	
Pressure	:	2.17 +0.03/-0.03 bar		main sterilization pressure with max. deviations	
Steril. time	:	5 min 30 s		maintained sterilization time	
Time	:	11:36:00 (End)		time at the end of the program	

21 201804321 5.15 5.04				information with total-cycle counter, factory serial number	
				and instrument software version number	

Fig. 5: Example for a text log of a successfully completed program.

9 Function tests

Automatic functional checks

The electronic parameter control subjects the interaction of the sterilization-relevant parameters pressure, temperature and time to constant automatic monitoring. The steam sterilizer process evaluation system compares the process parameters during the program with each other and monitors them in terms of their threshold values. The steam sterilizer monitoring system checks the device components for their functionality and their plausible interaction. Should the parameters exceed pre-set threshold values, the steam sterilizer emits warning messages or malfunction messages. If necessary, it interrupts the program with appropriate information. When the program has ended successfully, the corresponding message will be issued on the display.

Manual functional checks

You can follow the program run on the display via the values displayed there. You can also use the log recorded for every program to determine its success, see Logging.

Bowie & Dick test

The Bowie & Dick test serves as proof of steam penetration of porous materials such as e.g. textiles.

Specialist stockists provide various test systems for the Bowie & Dick test. Perform the test according to the test system manufacturer information.

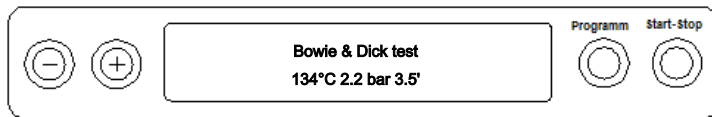

How to start the Bowie & Dick test program:

1. Switch on the device at the power switch.
2. Select the Bowie & Dick test by pressing the 'P' key repeatedly.
3. Press the 'S' key to start the Bowie & Dick test.

Following a successful test program, the current daily batch number is displayed, alternating with **Acknow. with '+' key**. You can open the door after pressing the '+' key.



PLEASE NOTE

If a log printer or another output medium is connected and the setting **Immediate output YES** is set, a log printout will be issued at the same time.



PLEASE NOTE

Treatment indicator strips often exhibit differing intensities in the colour change indicating a different length of storage of the manufacturer batches or other influences. Of crucial importance for evaluating the Bowie & Dick test is not the strength of contrast in the colour change on the test sheet, but its even nature.

If the treatment strips/treatment indicator sheet indicates an equal distribution of colour change, the venting of the sterilization chamber is without fault.

If the treatment indicator strips or the treatment indicator sheets are uncoloured or exhibit less colour in the centre of the star in comparison to the end, venting was insufficient. In this case, contact the authorized customer services / stockist technician.

Checking the quality of the feed water

You can access the water quality on the display at any time during a current program when the steam sterilizer is switched on.

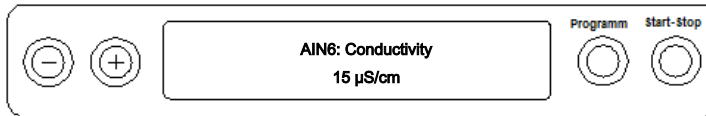

To do so, hold the '-' key depressed until the display shows **Conductivity**. The conductivity is displayed in µS/cm.

As soon as you have released the '-' key, the display returns to its previous state (e.g. initial state).

Checking the pre-heating temperature of the chamber

If pre-heating is activated, the steam sterilizer will warm the cold chamber or will maintain the temperature between two sterilization runs. This reduces program times and reduces the accretion of condensation, thus improving drying results.

After pressing the '-' key shortly twice and holding it depressed the second time, instead of displaying the conductivity, you will see the chamber pre-heating temperature.

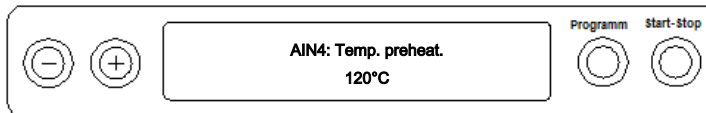

10 Maintenance

Servicing intervals

Interval	Measure	Device components
Weekly	Check for soiling, deposits or damage	Chamber inc. door seal and chamber sealing face, mount for the load
After 24 months or 1000 cycles	Maintenance	By the authorized customer services working in accordance with the maintenance instructions.
As required	Cleaning the surfaces	Housing parts

Cleaning



NOTICE

Inappropriately performed cleaning can lead to the scratching of and damage to surfaces and the development of leaks in sealing surfaces.

This also favours the development of soiling deposits and corrosion in the sterilization chamber.

- Comply with all information regarding cleaning of the part affected.

Door seal, chamber, chamber sealing face, mount, trays

Check the chamber, door seal, chamber sealing face and the load mount **once a week** for soiling, deposits or damage.

If you find any impurities, remove the trays or cassettes from the chamber from the front. Clean the soiled components.

When cleaning the chamber, load mount and chamber seal face, please comply with the following:

- ▶ Switch off the steam sterilizer before cleaning and remove the power plug from the socket.
- ▶ Ensure that the chamber is not hot.
- ▶ Use a soft, non-fuzzing cloth.
- ▶ First soak the cloth with the cleaning alcohol or spirit and attempt to wipe away impurities.
- ▶ Use a chlorine and vinegar-free cleaning fluid.
- ▶ Only if the chamber, mount or chamber sealing face has persistent soiling should you use a mild, non-scouring, stainless steel cleaning agent, with a pH value between 5 and 8.
- ▶ Use a neutral liquid cleaning agent to clean the door seal.
- ▶ You should not allow cleaning fluid to enter the piping coming from the chamber.
- ▶ Do not use any hard objects such as a metal saucepan cleaner or a steel brush.

Housing parts

Where necessary, clean the housing parts with a neutral fluid cleaner or spirit.

Internal storage tank

Should you use the internal storage tank for the feed water supply, perform regular checks and cleaning as follows:

Interval	
Upon every refill	Check the storage tank for soiling. If necessary, use a cloth and fresh feed water to clean the storage tank before filling.
Weekly	Replace the feed water.
Every 2 weeks	Clean the left-hand chamber of the storage tank (wastewater).



PLEASE NOTE

Keep the storage tank free of impurities.

Should you decide upon manual supply of the feed water via the internal storage tank, check the feed water side (the right-hand side) for soiling whilst refilling. If necessary, use a cloth and fresh feed water to clean the storage tank before filling.

Empty both chambers of the storage tank as follows:

1. Remove the filling funnel underneath the tank lid.
2. Open the device door. Connect the drain hose to the bottom left-hand connection on the device (left-hand wastewater tank, right-hand feed water tank). The device is fitted with either two quick couplings or two bleed valves.

Quick coupling:

the drain hose clicks touch-perceptibly.

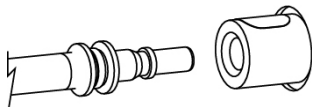

Bleed valve:

turn the drain hose anti-clockwise to its fullest extent.

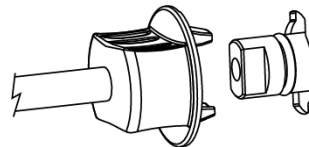

3. Discharge the water into a container with min. volume of 5 litres.
4. Repeat the procedure for the other chamber if necessary.
5. Return the filling funnel back underneath the filling funnel.
6. Comply with the following specifications to remove the drain hose:



CAUTION

Quick coupling: Danger of injury when removing the drain hose

- To empty the storage tank, stand in front of the connection to one side.
- Press the grey release knob on the quick coupling. Hold the hose with one hand whilst pressing the release knob with the other. This dampens the spring force of the seal. The hose will free itself from the coupling on its own.



CAUTION

Bleed valve: Danger of injury from knocking against the device door when removing the drain hose

- Turn the hose connection back to the vertical position.
- Remove the drain hose with both hands by pulling the drain hose downwards lightly away from the device.

Avoiding staining

Only after cleaning instruments properly prior to sterilization is it possible to avoid residue from the load or the instrument decontamination from being released during sterilization. Loosened dirt residue can clog the filter, nozzles and valves of the steam sterilizer and deposit themselves on the instruments and chamber as deposits and stains.

All steam-conducting parts of the steam sterilizer consist of non-rusting material. This rules out the possibility of stain or rust development being caused by the steam sterilizer. The development of rust is always extraneous rust.

Incorrect instrument decontamination can result in the accretion of rust even on stainless steel instruments of leading manufacturers. Often, an instrument which drops rust can suffice to cause the development of rust on another instrument or in the steam sterilizer. Remove foreign rust from the instruments using a chlorine-free stainless steel cleaning agent (see section [Cleaning](#) [▶ page 39]) or send the damaged instruments to the manufacturer.

The extent of stain accretion on the instruments is also dependant on the feed water used for steam generation.

Replacing the door seal

The door seal may not be greased or oiled. It should be kept clean and dry. If the door seal becomes worn or loses form, it must be replaced. Otherwise, this could result in leaks and the egress of steam. The door seal is only inserted in the groove of the round blank and can be changed as follows:

1. Open the steam sterilizer door and remove the old door seal.



2. Insert the door seal in the groove of the round blank.



PLEASE NOTE

Make sure that the broad seal face faces the chamber when inserting. The door can only be shut correctly and the chamber sealed, if the door seal sits correctly in the groove.

Replacing or sterilizing the sterile filter

The sterile filter must be replaced regularly within the scope of the maintenance. Given the incidence of a malfunction and the malfunction message F32: **Power failure/ Sterilize sterile filter** replace or sterilize the sterile filter.

Replacing the sterile filter

1. Remove the sterile filter by turning and pulling it from the holding sockets simultaneously.

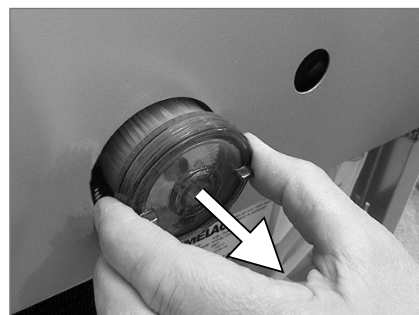

2. Replace the sterile filter **or** sterilize the current sterile filter, see [Sterilizing the sterile filter](#) [▶ page 43].

3. Exert a little pressure on the sterile filter and turn to insert it into the holding sockets.

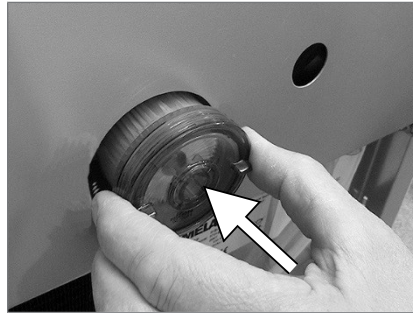

Sterilizing the sterile filter

1. Remove the sterile filter by turning and pulling it from the holding sockets simultaneously.

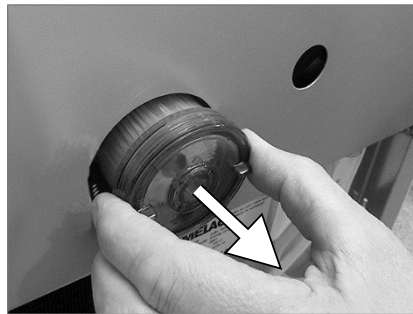

2. Slide a perforated tray into the steam sterilizer and place the sterile filter vertically on the tray. Ensure that the sterile filter does not fall over, otherwise the condensate will not be able to drain away correctly.



3. Start the Gentle-Program.
4. Remove the sterile filter from the device after the program end and allow it to cool for min. 15 minutes.
5. Exert a little pressure on the sterile filter and turn to bring it into the holding sockets.

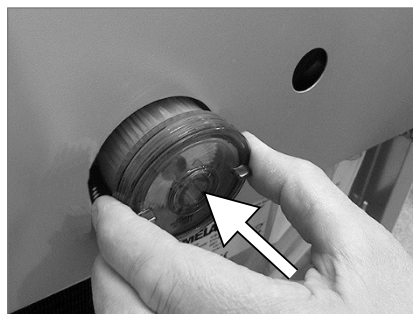

Cleaning the filter in the chamber

1. Unscrew the two fixing screws on the metal cover in the sterilization chamber (using e.g. a coin) and remove the metal cover.
2. Unscrew the “condensate return” (pos. a) and “vacuum/flow” (pos. b) filters anti-clockwise out of the opening to check and clean.

Use the spanner included in the scope of delivery (pos. c) to unscrew the “vacuum/flow” filter.

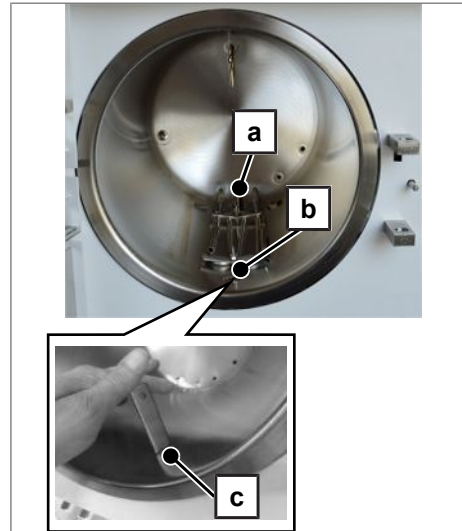

3. Rinse the filter (a and b) for cleaning with water.
4. Screw in the “condensate return” filter (pos. a) and the “vacuum/flow” filter (pos. b) clockwise into the opening.
5. Fasten the metal cover in the sterilization chamber with the two fixing screws.

Maintenance



NOTICE

Continuing operation beyond the maintenance interval can result in malfunctions in the device.

- Maintenance should only be performed by trained and authorized customer services technicians, or stockist technicians.
- Maintain the specified servicing intervals.

Regular maintenance is vital to ensure reliable operation and value retention of the steam sterilizer. All function and safety-relevant components and electrical units must be checked during maintenance and replaced where necessary. Maintenance is performed in accordance with the maintenance instructions pertinent to this steam sterilizer.

Arrange for regular maintenance in 24 months intervals or after 1000 program cycles. The steam sterilizer will issue a maintenance message at the relevant time.

11 Pause times

Frequency of sterilization

Pause times between individual programs are not necessary. After the end/abort of the drying time and removal of the sterilized equipment, you can load the steam sterilizer again and start a new program.

Operating pauses

Depending on the duration of the operating pauses, the following measures must be maintained:

Duration of the operating pause	Measure
Short pauses between two sterilization processes	<ul style="list-style-type: none"> ▪ Keep the door closed to save energy
Pauses which last longer than an hour	<ul style="list-style-type: none"> ▪ Switch off the steam sterilizer
Longer pauses e.g. over night or the weekend	<ul style="list-style-type: none"> ▪ Switch off the steam sterilizer ▪ Push the door to, to prevent premature wear and the sticking of the door seal. ▪ If present, shut off the water inflow of the water treatment unit
Longer than two weeks	<ul style="list-style-type: none"> ▪ Switch off the steam sterilizer ▪ Push the door to, to prevent premature wear and the sticking of the door seal. ▪ If present, shut off the water inflow of the water treatment unit <p>Upon re-commissioning:</p> <ul style="list-style-type: none"> ▪ Perform an empty sterilization run in Quick-Program S

After pauses, perform the checks described in chapter [Function tests](#) [▶ page 37] depending on the length of the pause.

Decommissioning

When decommissioning the steam sterilizer for a long pause (e.g. due to holiday or planned transport), proceed as follows:

1. Switch off the steam sterilizer at the power switch
2. Disconnect the power plug from the socket.
3. Close the water inflow if you are using a water treatment unit.



PLEASE NOTE

Comply with the specifications of the technical manual when transporting. The manual contains detailed instructions.

Recommissioning after relocation

When recommissioning after a move, proceed as with the first commissioning; see Technical Manual.

12 Malfunctions

Warnings

Warnings are not malfunction messages. They help to ensure malfunction-free operation and to recognize undesirable situations. Comply with these warnings early in order to avoid malfunctions.

Malfunction messages

Malfunction messages are issued on the display with an event number. This number serves identification purposes. Malfunction messages are issued when it is not possible to ensure safe operation or safety of sterilization. These can appear on the display shortly after activating the steam sterilizer or during a program run.

If a malfunction occurs during a program run, the program will be aborted.



WARNING

Danger of infection from early program abort

Aborting a program before the drying phase begins means that the load is unsterile. This endangers the health of your patients and practice team.

- If necessary, repack the load and repeat the sterilization for the sterilization material affected.

Before contacting customer services

Ensure that you have complied with all instructions relating to a warning or malfunction message issued by the display of the device. The following table contains a summary of the most important events. The events contain possible causes and the corresponding operator information.



CAUTION

Danger of burns from hot metal surfaces

- Allow the device to cool sufficiently before opening.
- Do not touch any hot metal parts.

Should the following table not contain the relevant event, or your efforts do not redress the problem, you can contact your nearest stockist or a local authorized MELAG customer service provider. Please have your device serial number and a detailed description of the malfunction contained in the notification to hand.

Warnings

Incident	Possible causes	What you can do
Notice: no feed water / refill feed water - start not possible	Only with feed water supply from an internal storage tank: insufficient water in the internal storage tank.	Check the water level of the feed water in the internal storage tank and refill with feed water if necessary.
Notice: no feed water / check the feed water inflow	When using the internal storage tank:	
	The warning will be displayed after a program start. The installed flow monitor does not close	Upon repeated incidence, contact an authorized customer services/stockist technician.
	When using a MELAG water treatment unit:	
	The warning will be displayed after a program start. The installed flow monitor does not close	MELAdem 40/53/53 C: check the water treatment unit and open the inflow to the system if necessary. Upon repeated incidence, contact an authorized customer services/stockist technician.
MELdem 47: check the water treatment unit and if necessary, open the inflow to the system. Perform a new start with an empty pressure storage after c. 1 hour. upon repeated incidence, contact an authorized customer services/stockist technician. PLEASE NOTE: This message can be issued following commissioning/ recommissioning, as the pipe system has not been filled completely. Repeat the start.		

Incident	Possible causes	What you can do
Poor feed water/ replace the cartridge or module	The conductivity of the feed water is too high. Conductivity $\geq 40 \mu\text{S/cm}$	Start by pressing of the 'S' key again is still possible.
	When using a MELAG water treatment unit:	
	The mixed-bed resin is exhausted.	MELAdem 40: replace the mixed-bed resin (art. no. 61026), see the operating manual of the MELAdem water treatment unit.
	The mixed-bed resin in the ion exchanger (3. cartridge) is exhausted.	MELAdem 47: replace the mixed-bed resin (art. no. 37470), see the operating manual of the MELAdem 47 water treatment unit and check the treatment unit. Following repeated incidence, arrange for maintenance to be performed by the authorized customer services/stockist technician. The pre-filter and activated carbon filter may require changing.
When using a different water treatment unit:		
	The mixed-bed resin in the reverse osmosis unit is exhausted.	Replace the module / resin cartridge in accordance with the manufacturer's operating manual. Maintenance is required following repeated incidence. PLEASE NOTE: Perform a program start after completing the work outlined above. This warning can be issued upon the initial start after maintenance of the water treatment unit, as the inflow hose / the measurement cell have not been completely rinsed with fresh water.
Insufficient quality of feed water / start not possible	Feed water conductivity too high. Conductivity $\geq 65 \mu\text{S}$	Start no longer possible. See warning: Poor feed water/replace the cartridge or module.
Please wait, the chamber is warming	This display appears during the program start phase. The steam sterilizer has not yet reached the starting temperature.	The steam sterilizer starts automatically after the starting temperature has been reached.
Notice: change the sterile filter	The min./max. pressure is exceeded/undercut during air drying; the sterile filter is soiled or torn.	Replace the sterile filter. PLEASE NOTE: The message comes at the end of the program and in the last line of the log output.
Output medium is not ready	The steam sterilizer is operating without an output medium, but one has been registered.	Working in the Log output menu, set the option No output medium .
	The output medium has not been connected properly.	Check that the data cable has been connected to the steam sterilizer and output medium correctly.
	The electricity supply to the printer has been interrupted.	Make sure that the power supply is connected. The red LED "P" on the MELAprint 42/44 log printer must illuminate red.
	The printer is offline.	Set the printer online (press the 'SEL' key on MELAprint 42/44, the "SEL" LED must illuminate green).

Incident	Possible causes	What you can do
Log memory full	The internal log memory of the device is full (max. 40 logs possible)	The notification is displayed upon program start Repeated pressing of the 'S' key removes the message and the program starts. The oldest log will be deleted in the process.
	An output medium has been registered and the option Immediate output NO has been set in the Log output menu.	<ol style="list-style-type: none"> 1. Set the steam sterilizer to Immediate output YES see Outputting logs immediately and automatically [▶ page 33]. 2. Delete the internal device memory, see Deleting logs in the internal log memory [▶ page 35]. If necessary, output all previously saved logs, see Subsequent log output [▶ page 33]. 3. Working in the Log output menu, log off the output medium and set the No output medium option.
Carry out maintenance	The maintenance message is activated. The device has reached the set number of batches or the running time of 2 years.	<p>The notification is displayed upon every program start.</p> <p>Repeated pressing of the 'S' key removes the message and the program starts.</p> <p>Retaining the notification: Press the 'S' key twice to start.</p> <p>Arrange for maintenance by the authorized customer services/stockist technician.</p> <p>PLEASE NOTE: The maintenance counter is reset by the customer services.</p>
Notice! Battery empty	Monitoring of the internal battery voltage has returned a low value.	The battery is to be replaced by the authorized customer services/stockist technician.

Fault messages

Incident	Possible causes	What you can do
F02	The overheat control has tripped.	Press the overheat control reset button on the fore side of the steam sterilizer at the bottom right-hand side (behind the cover) back in.
	The steam sterilizer is overloaded.	Comply with the maximum permissible load quantities, see Loading the steam sterilizer [▶ page 21].
	The incline of the steam sterilizer is incorrect.	<p>Check the incline of the steam sterilizer to the rear. Only a correct incline guarantees optimal metering of the water volume.</p> <p>Starting from a level position, extend the foremost device feet of the Euroklav 23 S+ by 5 rotations.</p>
	The mains voltage is too low, poor building voltage supply (e.g. undersized installation, defective socket, multiple devices on a single socket/fuse) so that the steam generator cannot heat up.	Check the building-side socket / test the steam sterilizer using a different socket or circuit.

Incident	Possible causes	What you can do
F04	The "condensate return" filter is soiled.	<ol style="list-style-type: none"> 1. Unscrew the two fixing screws on the metal cover in the sterilization chamber with an object e.g. a coin. 2. Remove the metal cover. 3. Unscrew the "condensate return" filter (in the rear of the sterilization chamber). 4. Check the "condensate return" filter for soiling and clean it if necessary, see Cleaning the filter in the chamber [▶ page 44].
	The outlet opening of the evaporator coil in the left-hand chamber of the storage tank (wastewater side) is impeded.	<p>Check the outlet opening of the evaporator coil as follows:</p> <ol style="list-style-type: none"> 1. Remove the tank lid from the internal storage tank. 2. Remove the filling funnel. 3. Check whether the outlet opening of the evaporator coil at the front underneath the tank lid is blocked or the rubber cover obscures the opening.
F08	The internal device time monitoring is defective.	Check the building-side socket / test the steam sterilizer using a different socket or circuit. Upon repeated incidence, arrange for an electrician to check the electricity supply for electromagnetic disruption.
F09	The door has not been closed correctly upon program start.	Close the door correctly and start the program again. PLEASE NOTE: To shut the door correctly, press it against the steam sterilizer lightly and slide the locking slider downwards to its fullest extent.
	An attempt was made to open the door during a program run.	Do not attempt to open the door during a program run.
F10	The overheat control of the tubular heating element has triggered.	Allow the steam sterilizer to cool for c. 2 minutes and then restart the program. PLEASE NOTE: This notification can be issued if a program is started immediately after a malfunction or a program abort.
	The incline of the steam sterilizer is incorrect.	Check the incline of the steam sterilizer to the rear. Only a correct incline guarantees optimal metering of the water volume. Starting from a level position, extend the foremost device feet of the Euroklav 23 S+ by 5 rotations.
F12	The door has not been closed correctly.	To shut the door correctly, press it against the steam sterilizer lightly and slide the locking slider downwards to its fullest extent.
	The locking pin for the door is stiff.	Open the door, switch off the steam sterilizer and press in the locking pin by hand. The pin must be free-moving. If necessary, clean the locking pin.
F18	Malfunction on the specified sensor input	Upon repeated incidence, contact an authorized customer services/stockist technician.
	With "Malfunction 18 Sensor: 6 Input: 6" an excessively high conductivity of the feed water supply can be measured.	Check whether the water used as feed water actually corresponds to the required quality or e.g. tap water has been used. The feed water must fulfil the quality requirements of DIN EN 13060, appendix C. If tap water has been used, restart the steam sterilizer 2-3 times so as to flush out the tap water from the system.
F21	The monitoring time of the preheating was exceeded	Upon repeated incidence, contact an authorized customer services/stockist technician.

Incident	Possible causes	What you can do
F22	The maximum preheating temperature has been exceeded	Upon repeated incidence, contact an authorized customer services/stockist technician.
F23	The pressure release of the sterilization chamber is blocked.	Unscrew the “flow” filter (in the fore area of the sterilization chamber) and check it for soiling. Clean the filter if necessary (see Cleaning the filter in the chamber [▶ page 44]).
	The outlet opening of the evaporator coil in the left-hand chamber of the storage tank (wastewater side) is impeded.	Check the outlet of the evaporator coil as follows: <ol style="list-style-type: none"> 1. Remove the tank lid from the internal storage tank. 2. Remove the filling funnel. 3. Check whether the outlet opening of the evaporator coil at the front underneath the tank lid is blocked.
F26	The internal computer signal processing has been interrupted.	Arrange for an inspection of the building-side installation (e.g. automatic circuit breaker) and test the steam sterilizer at another socket or on another circuit. Upon repeated incidence, contact an authorized customer services/stockist technician.
F27	The max. permissible temperature difference has been exceeded.	Arrange for an inspection of the building-side installation (e.g. automatic circuit breaker) and test the steam sterilizer at another socket or on another circuit. Upon repeated incidence, contact an authorized customer services/stockist technician.
F29	Insufficient battery voltage in the device.	Arrange for the battery to be replaced by an authorized customer services/stockist technician. <ol style="list-style-type: none"> 1. Acknowledge the malfunction message and then reset the date and time, see Setting the date and time. 2. Start the program again.
F32	The steam sterilizer was switched off at the power switch during a program run.	Replace or sterilize the sterile filter as follows: <ol style="list-style-type: none"> 1. Remove the sterile filter from the rear panel of the steam sterilizer and sterilize it in the Gentle-Program without continuing loading. 2. Return the sterile filter to the rear panel. Never switch off the steam sterilizer at the power switch during a program run. Always abort a program with the “Start-Stop” key.
	The power plug has been disconnected or has not been connected correctly in the socket.	Check whether the power plug is connected, the power cable has suffered damage or a loose contact or loose plug connections is the cause. Plug the power plug back into the mains socket.
	Power outage in the building supply.	Arrange for an inspection of the building-side installation (e.g. automatic circuit breaker) and test the steam sterilizer at another socket or on another circuit.
F33	The control pressure has not been achieved.	Upon repeated incidence, contact an authorized customer services/stockist technician.
	The steam sterilizer is overloaded.	

Incident	Possible causes	What you can do
F34	The sterilization temperature on temperature sensor 1 was undercut. The steam sterilizer may be overloaded.	Comply with the maximum permissible load quantities, see Loading versions.
	The door seal and/or the seal face on the sterilization chamber is soiled or the door seal is defective.	Check the door seal and the seal face on the sterilization chamber for soiling and foreign bodies and clean them if necessary. Check the door seal for defects and replace if necessary. See Replacing the door seal [▶ page 41].
	The door seal was not inserted correctly.	Check whether the door seal has been inserted correctly. See Replacing the door seal [▶ page 41]. Insert the new door seal in the groove in such a way that the wider seal face points towards the side of the sterilization chamber.
F35	The sterilization temperature on temperature sensor 1 was exceeded.	Upon repeated incidence, contact an authorized customer services/stockist technician.
F36	The required chamber pressure was undercut during sterilization. The steam sterilizer may be overloaded.	Comply with the maximum permissible load quantities, see Loading the steam sterilizer [▶ page 21].
	The door seal and/or the seal face on the sterilization chamber is soiled or the door seal is defective.	Check the door seal and the seal face on the sterilization chamber for soiling and foreign bodies and clean them if necessary. Check the door seal for defects and replace if necessary. See Replacing the door seal .
	The door seal was not inserted correctly.	Check whether the door seal has been inserted correctly. See Replacing the door seal . Insert the new door seal in the groove in such a way that the wider seal face points towards the side of the sterilization chamber.
F37	The max. permissible sterilization pressure has been exceeded.	Upon repeated incidence, contact an authorized customer services/stockist technician.
F38	The max. permissible temperature difference on temperature sensor 1 has been exceeded.	Upon repeated incidence, contact an authorized customer services/stockist technician.
F39	The internal memory (EEPROM) has suffered data inconsistency or data loss.	<ol style="list-style-type: none"> 1. Acknowledge the malfunction message and if necessary, reset the date and time, see Setting the date and time [▶ page 19]. 2. Start the program again.
F41	see event F23	

Incident	Possible causes	What you can do
F42	The door seal and/or the seal face on the sterilization chamber is soiled or the door seal is defective.	Check the door seal and the seal face on the sterilization chamber for soiling and foreign bodies and clean them if necessary. Check the door seal for defects and replace if necessary. See Replacing the door seal.
	The door seal was not inserted correctly.	Check whether the door seal has been inserted correctly (see Replacing the door seal). Insert the new door seal in the groove in such a way that the wider seal face points towards the side of the sterilization chamber.
	The incline of the steam sterilizer is too flat.	Check the incline of the steam sterilizer to the rear. Complete condensate drainage from the chamber is only possible with a sufficient rearwards incline. Starting from a level position, extend the foremost device feet of the Euroklav 23 S+ by a minimum of 5 rotations.
	The sterile filter is soiled.	Remove the sterile filter from the rear panel of the steam sterilizer. Check the sterile filter for soiling and perform an empty sterilization run without a sterile filter. If the empty sterilization run is successful, replace the sterile filter (see Replacing or sterilizing the sterile filter [▶ page 42]).
F48	Parameter malfunction	Switch off the steam sterilizer and back on again and then restart the program. Upon repeated incidence, contact an authorized customer services/stockist technician.
F51	The sterilization temperature on temperature sensor 2 was undercut. The steam sterilizer may be overloaded.	Comply with the maximum permissible load quantities, see Loading the steam sterilizer [▶ page 21].
	The door seal and/or the seal face on the sterilization chamber is soiled or the door seal is defective.	Check the door seal and the seal face on the sterilization chamber for soiling and foreign bodies and clean them if necessary. Check the door seal for defects and replace if necessary. See Replacing the door seal.
	The door seal was not inserted correctly.	Check whether the door seal has been inserted correctly. See Replacing the door seal. Insert the new door seal in the groove in such a way that the wider seal face points towards the side of the sterilization chamber.
F52	The sterilization temperature on temperature sensor 2 was exceeded.	Upon repeated incidence, contact an authorized customer services/stockist technician.
F53	The max. permissible temperature difference on temperature sensor 2 has been exceeded.	Upon repeated incidence, contact an authorized customer services/stockist technician.

Opening the door in an emergency following a power outage



WARNING

The steam sterilizer must be completely pressure free.

Failure to observe this provision can result in scalding/injury.

- No steam may be permitted to leave from between the sterile filter and the rear panel of the steam sterilizer.
- The slide seal grip must be easy to actuate.
- It must be possible to push the door c. 2 mm to the rear with light pressure.
- It is imperative that you allow the steam sterilizer to cool. Metal parts such as the door and chamber can be hot.

Should it not be possible to open the door e.g. following a power outage, taking into account the safety information specified above, proceed as follows:

1. Switch off the steam sterilizer at the mains and remove the plug from the socket.
2. To effect emergency release of the door, position long side of the lever between the door and the side wall of the steam sterilizer. The curve points forwards; the lever is at the level of the slide seal grip.

If the lever is in the guide, pull it forwards with your right hand. Push the slide locking grip upwards with your other hand.

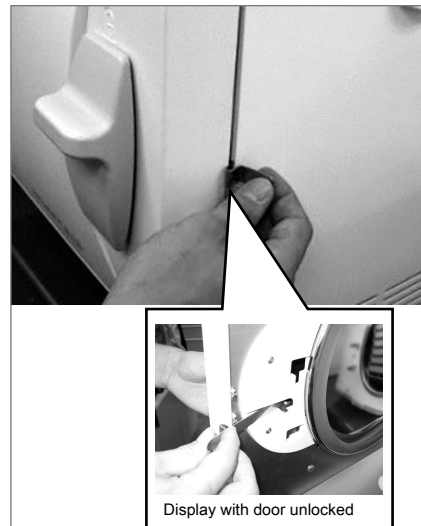

3. Open the door.



Replacing the device fuses

If the device fuses (see views of the device) have been tripped, proceed as follows to change them:

1. Switch off the steam sterilizer at the mains and remove the plug from the socket.
2. Open the door manually, see Opening the door in an emergency following a power outage.
3. Unscrew and remove the two screw caps in the fuse holder (see Views of the device) on the lower front of the steam sterilizer with a screw driver or coin. Two replacement fuses are mounted on the inside of the door (see marking).

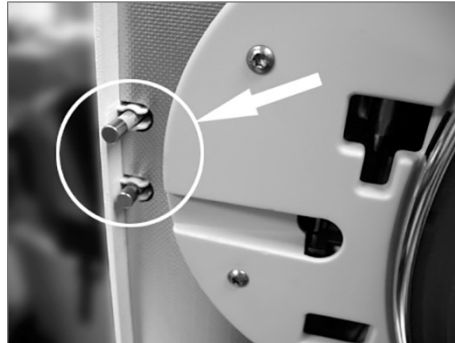

4. Remove the defective fuses and insert the new fuses securely in their holder.



5. Screw the cap of the fuse holder to the lower front of the steam sterilizer.
6. Reconnect the steam sterilizer plug to the socket and switch on the steam sterilizer at the power switch.

Should this trigger repeatedly, please inform the authorized customer services/stockist technician.

13 Technical data

Device type	Euroklav 23 S+
Device dimensions (H x W x D)	49 x 42.5 x 70 cm
Chamber diameter/depth	Ø 25 cm 45 cm
Chamber volume	22.6 litres
Volume (internal water storage container)	5 litres
Empty weight	45 kg
Operating weight ¹⁾²⁾	55 kg
Max. Floor loading (hydraulic pressure test) ²⁾	67.6 kg
Electricity supply	220-240 V, 50/60 Hz, 2300 W
Building fuses	16 A fuse, FI protection 30 mA
Waste heat (with maximum load)	0.9 kWh
Noise emission	64 dB(A)
Ambient temperature	5-40 °C (ideal range 16-26 °C)
Relative humidity	max. 80 % at 31 °C, decreases in a linear fashion up to max. 50 % relative humidity at 40 °C
Max. height	2000 m
Length of the power cable	1.35 m
Degree of protection (following IEC 60529)	IP20
CE marking	CE 0197, CE 0035
Feed water connection³⁾	
Water quality	Distilled or demineralized feed water in accordance with DIN EN 13060, Appendix C (with central demineralization system max. conductivity 5 µS/cm)
Recommended flow pressure	1.5 at 3 l/min.
Max. water pressure (static)	10 bar
Max. water consumption ⁴⁾	c. 700 ml
Wastewater connection	
Max. water temperature	70 °C ⁵⁾
Volume storage tank	Feed water (right-hand chamber) 5 litres (c. 7 cycles) Wastewater side (left-hand chamber) 3 litres

¹⁾ Depending on the load, the weight can increase by up to 4 kg.

²⁾ When using a water treatment unit, take into account its additional weight.

³⁾ When using a water treatment unit

⁴⁾ In the Prion-Program a with porous full load.

⁵⁾ Optional: automatically via the one-way discharge with the MELAG upgrade kit for the tank drain.

14 Accessories and spare parts

You can obtain the specified articles and an overview of further accessories from your stockist.

Category	Article	Art. no.
Mounts	Mount A "Plus" for 5 trays or 3 standard tray cassettes or 3 MELAstore-Boxes 100	82630
	Mount B For 4 standard tray cassettes	40224
	Mount D For 2 high cassettes or 4 trays	46840
Sterilization container with disposable paper filters in accordance with DIN EN 868-8 (depth x width x height)	15K (18 x 12 x 4.5 cm)	01151
	15M (35 x 12 x 4.5 cm)	01152
	15G (35 x 12 x 8 cm)	01153
	17K (20 x 14 x 5 cm)	01171
	17M, for 45 cm chamber depth (41 x 14 x 5 cm)	01172
	17G, for 45 cm chamber depth (41 x 14 x 9 cm)	01173
	23M, for 45 cm chamber depth (42 x 16 x 6 cm)	01231
	23G, for 45 cm chamber depth (42 x 16 x 12 cm)	01232
	28M (32 x 16 x 6 cm)	01284
28G (32 x 16 x 12 cm)	01285	
Swab drum with filter cloth (diameter x height)	Swab drum 17R (Ø13 x 10.5 cm)	00174
	Swab drum 23R (Swab drum 23R)	00233
Package holder	Package holder (Ø 25 cm)	22420
Standard tray cassettes (depth x width x height)	Standard tray cassette, perforated (with filter cloth) (29 x 19 x 4 cm)	00289
	Standard tray cassette, perforated (without filter cloth) (29 x 19 x 4 cm)	00286
Trays	Tray	00230
Water treatment units	MELAdem 40 ion exchanger	01049
	MELAdem 47 reverse osmosis unit	01047
	MELAjet spray pistol for MELAdem 40	27300
For documentation:	MELAflash CF card printer inc. MELAflash CF-Card and card reader	01039
	MELAnet Box	40296
	MELAprint 44 log printer	01144
Spare Parts	Water stop (leakage water detector)	01056
	Device fuses 20 A gRL	57589
	Door seal	58512
	Sterile filter	20160
	Slide clips for mounts "Plus", 10 pcs.	81235

Glossary

Air leakage

An air leakage is a location through which air can pass in and out without this being desired. Verification of the leakage serves to prove that the volume of air ingress in the chamber during the vacuum phase does not exceed a value which would prevent steam penetration of the sterilizer load and that the air leakage does not cause the possible contamination of the sterilizer load during the drying phase.

AKI

Abbr.: working group instrument preparation ("Arbeitskreis Instrumentenaufbereitung")

Authorized personnel

An authorized personnel can be medical stockists, depot technicians or MELAG-authorized customer services trained by MELAG.

Batch

The total load which has been subject to the same decontamination procedure.

BGVA 1

BGV is the abbreviation for Berufsgenossenschaftliche Vorschriften (regulations from a professional association). A1 stands for principles of prevention

Bowie & Dick test

Steam penetration test with a standard test package; described in DIN EN 285; the test is recognized in the large-scale sterilization industry.

CF card

Abbr.: "Compact Flash Card"; a memory card for digital data with a compact size. CF is a standard.

Condensate

Fluid (e.g. water) produced by the cooling of and resultant separation from the vaporous state.

Conductivity

Conductivity is the opposite of electrical resistance; measured in micro-Siemens/centimetre ($\mu\text{S}/\text{cm}$); the greater the amount of dissolve matter in the water, the better it can conduct electrical current and thus the higher its conductivity.

Corrosion

The chemical alteration or destruction of metal materials by water and chemicals

Delay in boiling

This refers to the phenomenon that it is possible under certain circumstances to heat a fluid beyond its boiling point without them boiling. This represents an unstable state; even low-level agitation can produce a large bubble within the shortest period, which expands explosively.

Demineralized water

Water without the minerals usually found in normal spring or tap water; is produced through ion exchange of normal tap water. It is used here as feed water.

DGSV

Abbr.: Deutsche Gesellschaft für Sterilgutversorgung (German Society German Society for Sterile Supply). The DGSV training centres are specified in DIN 58946, part 6 as "Requirements of personnel".

DIN 58953

Standard – sterilization, sterile equipment supply

DIN EN 13060

Standard – small steam sterilizers

DIN EN ISO 11607-1

Standard - packaging for medical devices to be sterilized in the final packaging - Part 1: Requirements placed on materials, sterile barrier systems and packaging systems

Distilled water

From the Latin aqua destillata; also referred to as aqua dest; water which to a great extent is free from salts, organic material and micro-organisms, is produced from normal tap water or pre-cleaned water through the process of distillation (evaporation and subsequent condensation). It is used here as feed water.

Dynamic pressure test of the sterilization chamber

Serves to prove that the rate of pressure variations during a sterilization cycle does not exceed a particular value which could result in the damage of the packaging material. [see also DIN EN 13060]

Empty chamber test

Test run without a load, performed to assess the performance of a sterilizer without the influence of a load; facilitating verification of the temperatures maintained in comparison to the temperatures set. [see also DIN EN 13060]

Feed water

Feed water is required to produce steam for sterilization. Guide values for water quality in accordance with DIN EN 285 / DIN EN 13060 – Appendix C

Heat-up phase

The time required after the steam sterilizer has been switched on / after the start of a sterilization program, to heat the double-jacket steam generator before the sterilization procedure starts. The duration is dependent on temperature at which sterilization takes place.

MELAG network adapter

Ethernet printer module for the MELAprint 42/44 log printer; a printer connection on one side and a network connection on the other

Mixed loads

wrapped and unwrapped sterilization material within a single load

Multiple wrapping

e.g. wrapped instruments sealed in a double layer of film or wrapped in film and placed in an additional container or a container wrapped in textiles.

Porous

Permeable for fluids and air e.g. textiles

Porous full load

Serves to prove that the values set on the control satisfy the necessary sterilization conditions in porous loads with a maximum mass for which the sterilizer is designed in accordance with DIN EN 13060 [see also DIN EN 13060].

Porous partial load

Serves to prove that the values set on the control allow steam to enter the pre-determined test package quickly and equally [see also DIN EN 13060]

Process evaluation system

Also known as the self-monitoring system – this observes itself and compares the various sensors during a current program.

Product with narrow lumen

An article open on one side to which the following applies: $1 \leq L/D \leq 750$ and $L \leq 1500$ mm or an article with an opening on both sides which is: $2 \leq L/D \leq 1500$ and $L \leq 3000$ mm and which does not correspond to a hollow body article B; L...length of hollow body article; D...Diameter of hollow body article [see also DIN EN 13060]

RKI

Abbr.: "Robert-Koch-Institute". It is one of the most important bodies for the safeguarding of public health in Germany.

Simple hollow bodies

An article open on one side to which the following applies: $1 \leq L/D \leq 5$ and $D \geq 5$ mm or an article with an opening on both sides which is: $2 \leq L/D \leq 10$ and $D \geq 5$; L...hollow body article length; D...hollow body article diameter [see also DIN EN 13060]

Single wrapping

Wrapped once e.g. instruments sealed in foil – in opposition to: Multiple wrapping

Soft sterilization packaging

e.g. a paper bag or transparent sterilization packaging.

Solid

Without hollows or gaps, solid, compact, closed

Solid load

Serves to prove that the necessary sterilization conditions have been reached within the entire load with the values set in the control. The load must represent the largest weight of massive instruments designed for sterilization in a sterilizer in accordance with DIN EN 13060. [see also DIN EN 13060]

Sterile barrier system

A closed minimum packaging which prevents the entrance of micro-organisms e.g. through sealing bags, sealed and re-usable containers and folded sterilization towels etc.

Sterilization chamber

The interior of a sterilizer accommodates the sterilization material

Sterilization material

Unsterile, sterilizable material which is still to be sterilized.

Sterilized equipment

Also referred to as a batch: a load which has already been sterilized, i.e. is sterile

VDE

Abbr. (German): "Verband der Elektrotechnik, Elektronik und Informationstechnik e.V." (Alliance of the Electronics, Electrotechnical and IT Industry).

MELAG Medizintechnik oHG

Geneststraße 6-10
10829 Berlin
Germany

email: info@melag.com
Web: www.melag.com

Responsible for content: MELAG Medizintechnik oHG
We reserve the right to technical alterations

Your stockist

